

Manual

Software SPECTRO3-MSM-ANA-Scope V2.1

(PC software for Microsoft® Windows® XP, VISTA, 7)

for color sensors of SPECTRO-3-MSM-ANA Series with internal temperature compensation and white light balancing

This manual describes the installation of the PC software for the SPECTRO-3-MSM-ANA color sensor. As a support for commissioning of the color sensor this manual explains the functional elements of the Windows® user interface.

The SPECTRO-3-MSM-ANA provides highly flexible signal acquisition. For example, the sensor can be operated in alternating-light mode (AC mode), which makes the sensor insensitive to extraneous light. It also can be set to constant-light mode (DC mode), which makes the sensor extremely fast. With the stepless adjustment of the integrated light source as well as the selectable gain of the receiver signal and an INTEGRAL function the sensor can be set to almost any surface or any "self-luminous object".

When the integrated light source of the SPECTRO-3-MSM-ANA color sensor is activated, the sensor detects the radiation that is diffusely reflected from the object. As a light source the SPECTRO-3 color sensor uses a white-light LED with adjustable transmitter power. An integrated 3-fold receiver for the red, green, and blue content of the light that is reflected from the object, or the light that is emitted by a "self-luminous object", is used as a receiver.

The SPECTRO-3-MSM-ANA color sensor can be "taught" up to 3 colors. For each of these taught colors it is possible to set tolerances. Depending on the settings the taught colors represent a color cylinder or a color sphere in space. Evaluation of the taught colors is performed either with the "FIRST HIT" or with the "BEST HIT" mode. With "FIRST HIT" the first hit in the teach table is output, and with "BEST HIT" the best hit in the teach table is output. Raw data are represented with 12 bit resolution.

Color detection either operates continuously or is started through an external PLC trigger signal. The respective detected color either is provided as a binary code at the 2 digital outputs or can be sent directly to the outputs, if only up to 2 colors are to be detected.

In addition to the 2 digital outputs there also are 3 analog outputs that either provide the red, green, and blue components or the calculated color coordinates in values of 0-10V.

Through input IN0 (green wire of the cab-las8/SPS cable) the color sensor can be taught up to 3 colors. For this purpose the corresponding parameter mode must be set with the software.

Parameters and measurement values can be exchanged between a PC and the SPECTRO-3-MSM-ANA color sensor through the serial RS232 interface. All the parameters for color detection also can be saved to the non-volatile EEPROM of the SPECTRO-3-MSM-ANA color sensor through this serial RS232 interface. When parameterisation is finished, the color sensor continues to operate with the current parameters in STAND-ALONE mode without a PC.

The sensors of the SPECTRO-3-MSM-ANA series can be calibrated. Calibration can be performed to any surface with known color coordinates. A ColorChecker™ table is available as an alternative. This table has 24 color fields according to the CIE STANDARD that can be used for calibration.

0 Contents

	Page
1. Installation of the SPECTRO3-MSM-ANA-Scope software	3
2. Operation of the SPECTRO3-MSM-ANA-Scope software.....	4
2.1 Tab CONNECT	5
2.2 Tab PARA1, button SEND, GET, GO, STOP (parameterization, data exchange)	7
2.3 Graphic display elements	15
2.4 Tab TEACH (teach table)	17
2.5 Tab GEN (color rows and color specifications)	21
2.6 Tab REC (data recording)	22
2.7 Tab CALIB.....	24
2.7.1 Calibration	24
2.7.2 Offset calibration	27
2.8 Tab SCOPE	28
3. Operation of the TEMPCOMP-Scope software	29
4. External triggering of the SPECTRO-3-MSM-ANA color sensor	30
5. Connector assignment of the SPECTRO-3-MSM-ANA color sensor.....	31
6. RS232 communication protocol.....	32

Shortcuts:

SEND	F9
GET	F10
GO	F11
STOP	F12

1. Installation of the SPECTRO3-MSM-ANA-Scope software

The following requirements must be fulfilled for successful installation of the SPECTRO3-MSM-ANA-Scope software:

- Microsoft® Windows® XP, VISTA, 7
- IBM PC AT or compatible
- VGA graphics
- Microsoft-compatible mouse
- CD-ROM drive
- Serial RS232 interface at the PC or USB slot
- Cable **cab-las4/PC** for the RS232 interface or **cab-las4/USB** for USB slot

The SPECTRO3-MSM-ANA-Scope software can only be installed under Windows. Windows must therefore be started first, if it is not yet running.

Please install the software as described below:

1. The software can be installed directly from the installation CD-ROM. To install the software, start the SETUP program in the SOFTWARE folder of the CD-ROM.
2. The installation program displays a dialog and suggests to install the software in the C:\"FILENAME" directory on the hard disk. You may accept this suggestion with **OK** or **[ENTER]**, or you may change the path as desired. Installation is then performed automatically.
3. During the installation process a new program group for the software is created in the Windows Program Manager. In the program group an icon for starting the software is created automatically. When installation is successfully completed the installation program displays "Setup OK".
4. After successful installation the software can be started with a left mouse button double-click on the icon.

Windows® is a trademark of the Microsoft Corp.
VGA™ is a trademark of the International Business Machines Corp.

2. Operation of the SPECTRO3-MSM-ANA-Scope software

Please read this chapter first before you start to adjust and parameterise the SPECTRO-3-MSM-ANA color sensor.

When the SPECTRO3-MSM-ANA-Scope software is started, the following window appears on the Windows interface:

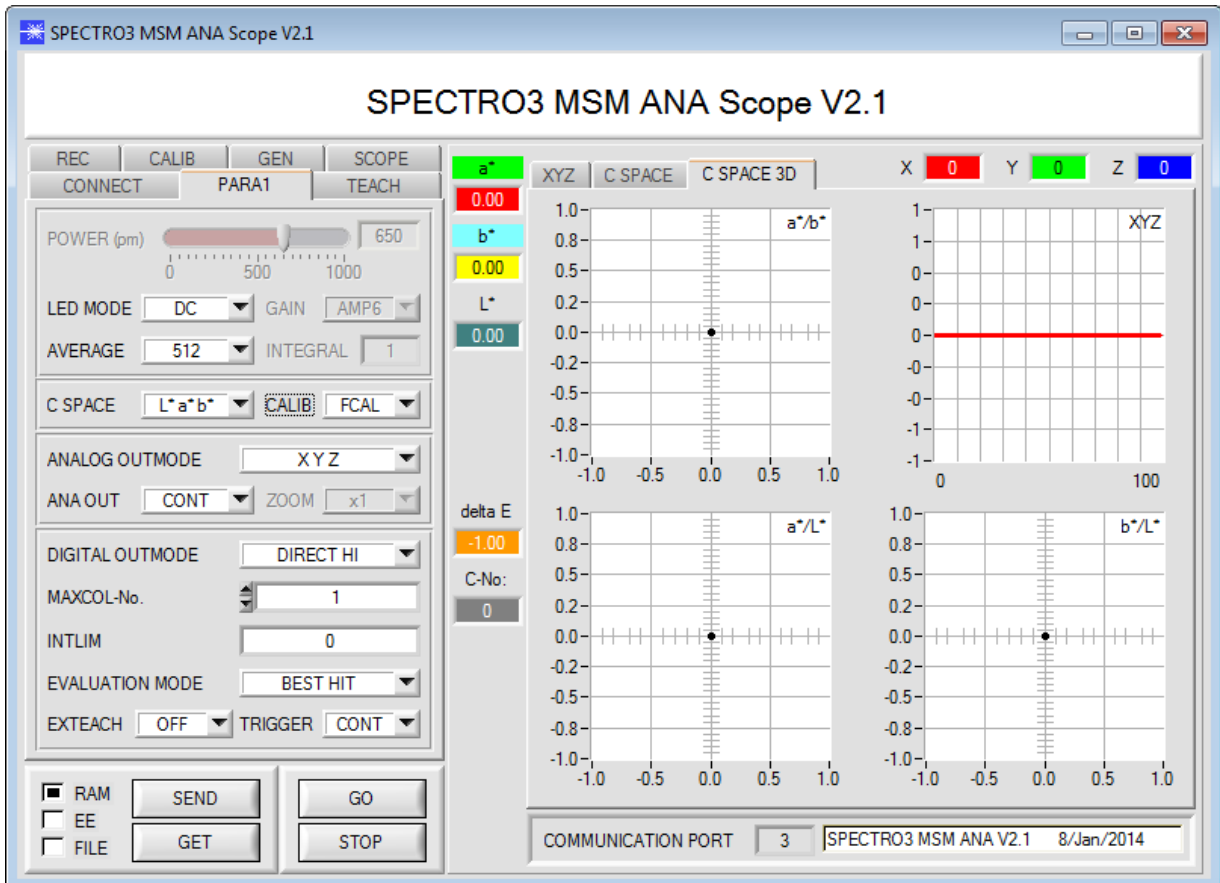

The window size and position will be the same as when the software was last closed. A double-click with the right mouse button e.g. under the minimise symbol places the window centrally in its original size.

If a connection is not established automatically, e.g. if no sensor is connected, the software can be run in OFFLINE mode. In offline mode it only is possible to exchange parameters with a file on a storage medium, which often is helpful for the purpose of analysing parameter files.

If a sensor is connected and a connection still cannot be established, either the SCOPE version (program at the PC) and the firmware version (program in the sensor) do not match, or the interface to the sensor must be correctly configured.

If different Scope and firmware versions should be the problem, please get the Scope version that matches the firmware from your supplier.

The interface configuration is described in the CONNECT tab chapter.

Pressing the right mouse button on an individual element will call up a short help text.

2.1 Tab CONNECT

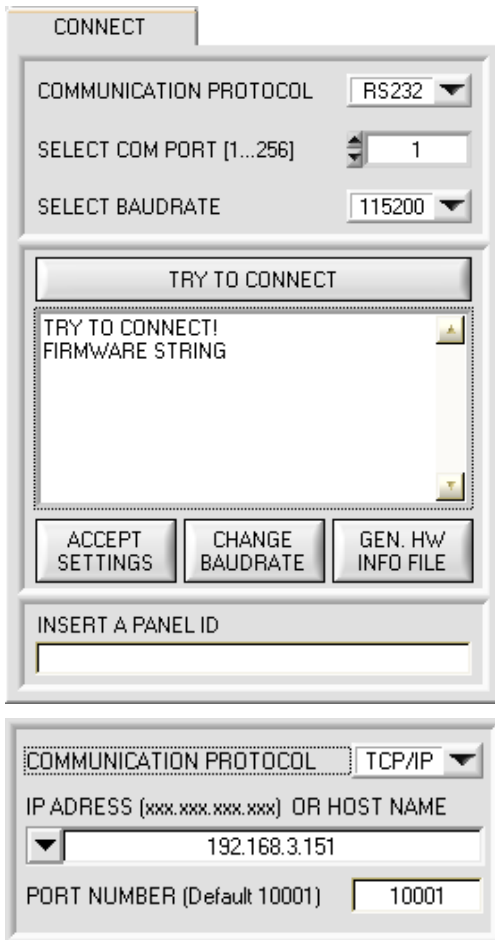

CONNECT:

Pressing the **CONNECT** tab opens a window for selecting and configuring the interface.

The **COMMUNICATION PROTOCOL** function field is used for selecting either an **RS232** or a **TCP/IP** protocol.

If **RS232** is selected, a port from 1 to 256 can be selected with **SELECT COM PORT**, depending on which port the sensor is connected to.

The sensor operates with a set baudrate that can be modified with **CHANGE BAUDRATE** (see below). The sensor and the user interface both must operate with the same baudrate. At the user interface the baudrate is set with **SELECT BAUDRATE**. If after starting the software should not automatically establish a connection, the correct baudrate can be found with **SELECT BAUDRATE**.

If an adaptor is used, the **COM PORT** number can be determined by way of the hardware manager in the system control panel.

If the sensor should communicate through a local area network, an RS232 to Ethernet adaptor will be needed. This adapter makes it possible to establish a connection to the sensor with the **TCP/IP** protocol.

The network adaptors that are available from us are based on the Lantronix XPort module. For parameterising these adapters (assigning of an IP address, setting of the Baud rate of 19200) please download the "DeviceInstaller" software that is provided free of charge by Lantronix at <http://www.lantronix.com/>. DeviceInstaller is based on Microsoft's ".NET" framework. Detailed operating instructions for the "DeviceInstaller" software also are available from Lantronix.

In order to establish a connection to the adaptor, its IP address or HOST name must be entered in the field **IP ADDRESS (xxx.xxx.xxx.xxx) OR HOST NAME**. The DROP DOWN menu (down arrow) shows the last 10 IP addresses that were used. An address from this list can be directly selected by clicking on the respective item. The DROP DOWN list is saved and is thus always available when the software is closed.

The **PORT NUMBER** for the XPort-based network adaptors is 10001. This port number must not be changed.

When you press the **TRY TO CONNECT** button, the software tries to establish a connection with the set parameters. The communication status is shown in the display field. If the sensor answers with its FIRMWARE ID, the set connection type can be accepted by pressing **ACCEPT SETTINGS**. You will then be returned to the **PARAMETER** tab. If you get a **TIMEOUT** message, the software could not establish a connection to the sensor. In this case please check if the interface cable is correctly connected, if the sensor is supplied with power, and if the set parameters are correct.

If a connection has been accepted by pressing **ACCEPT SETTINGS**, the software starts automatically with these settings when called the next time.

DISCONNECT disconnects the connection between sensor and PC. The software then switches to OFFLINE mode, where it is only possible to exchange parameters with a file on a storage medium.

<p>Please note:</p>  <p>ATTENTION !</p>	<p>The stable function of the interface is a basic prerequisite for measured value transfer from the PC to the sensor.</p> <p>Due to the limited data transfer rate through the serial RS232 interface only slow changes of the raw signals at the sensor front end can be observed in the graphic output window of the PC.</p> <p>For maintaining maximum switching frequency at the sensor data communication with the PC must be stopped (press the STOP button).</p>
------------------------------------------------------------------------------------------------------------------------------------------	-----------------------------------------------------------------------------------------------------------------------------------------------------------------------------------------------------------------------------------------------------------------------------------------------------------------------------------------------------------------------------------------------------------------------------------------------------------------------------------------------

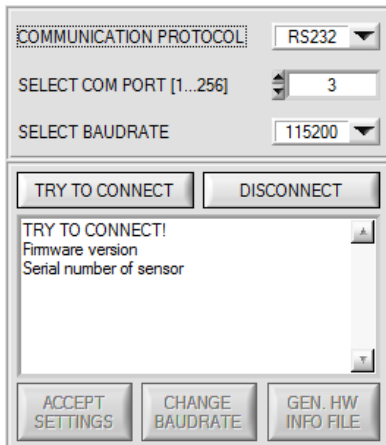

The baudrate for data transfer through the RS232 interface can be set by means of the **SELECT BAUDRATE** drop down menu and **CHANGE BAUDRATE** function field.

If the baudrate should be changed, a connection must first be established by clicking on **TRY TO CONNECT**.

The **CHANGE BAUDRATE** button will then be active.

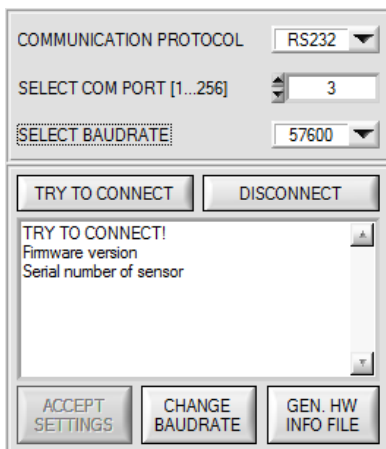

Now a new baudrate can be selected under **SELECT BAUDRATE**.

A click on **CHANGE BAUDRATE** sends the new baudrate information to the sensor.

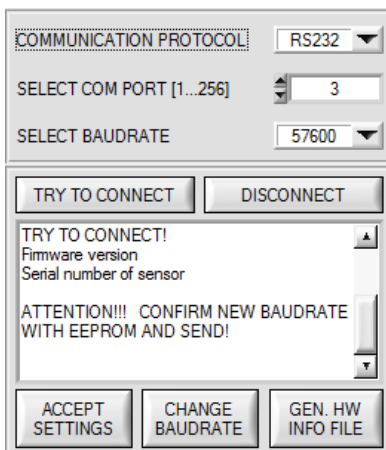

When the new baudrate information has been successfully sent, the sensor operates with the new baudrate. A window will pop up, prompting you to select **EEPROM** and then to press **SEND**. After a hardware reset the new baudrate only will be used when **EEPROM** and **SEND** have been pressed.

A click on **ACCEPT SETTINGS** saves the current interface settings, which will then be automatically set when the software is restarted.

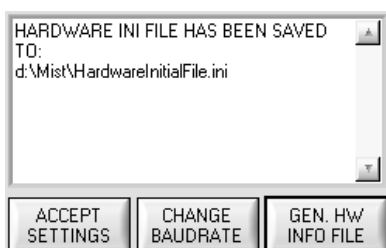

A click on the **GEN. HW INFO FILE** generates a file in which all the important sensor data are stored in encrypted form.

This file can be sent to the manufacturer for diagnostic purposes.

2.2 Tab PARA1, button SEND, GET, GO, STOP

PARA1:

Pressing the **PARA1** tab opens a window for setting the sensor parameters.

ATTENTION!

A change of the parameter function groups only becomes effective at the sensor after actuation of the SEND button in the MEM function field!

SEND [F9]:

When the **SEND** button is clicked (or shortcut key button F9 is pressed), all the currently set parameters are transferred between PC and sensor. The target of the respective parameter transfer is determined by the selected button (**RAM**, **EEPROM**, or **FILE**).

GET [F10]:

The currently set values can be interrogated from the sensor by clicking on the **GET** button (or with shortcut key button F10). The source of data exchange is determined by the selected button (**RAM**, **EEPROM**, or **FILE**).

RAM:

After a click on the **SEND** button the current parameters are written into the **RAM** memory of the sensor, or they are read from the **RAM** by clicking on the **GET** button, i.e. these parameters are lost when the voltage at the sensor is switched off.

EEPROM:

After a click on the **SEND** button the current parameters are written into the non-volatile memory of the **EEPROM** in the sensor, or they are read from the **EEPROM** by clicking on the **GET** button, i.e. the parameters in the internal **EEPROM** are stored when the voltage at the sensor is switched off.

FILE:

After pressing **SEND**, the current parameters can be written to a selectable file on the hard disk. With **GET** parameters can be read from such a file. When the **SEND** or **GET** button is pressed, a dialog box opens for selecting the desired file.

GO [F11]:

A click on this button (or with shortcut key button F11) starts data transfer from the sensor to the PC through the serial RS232 interface.

SOURCE is used to select which signals should be shown in the displays and graphs.

STOP [F12]:

A click on this button (or with shortcut key button F12) stops data transfer from the sensor to the PC through the serial RS232 interface.

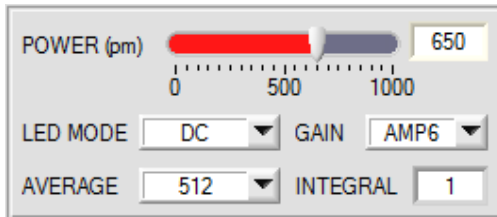

POWER:

The transmitter power is constantly kept at the value set with the **POWER [pm]** slider (recommended operation mode). The **POWER** can be set with the slider or by entering a value in the edit-box. A value of 1000 means full intensity at the transmitter unit, a value of 0 sets the lowest intensity at the transmitter.

POWER only is available with **CALIB=OFF**.

LED MODE:

This item serves for setting the control mode for the integrated light source of the sensor.

DC: In this mode the sensor operates extremely fast. Unfortunately the sensor is somewhat sensitive to extraneous light in DC mode, but if the extraneous light source does not directly shine into the sensor's receiver, the signal only is influenced to a very small extent.

AC: In this mode the sensor is insensitive to extraneous light, which is achieved by "modulating" the integrated light source, i.e. by turning the light on and off. The extraneous content in the signal is determined in off status and is simply subtracted from the on status.

GAIN:

This item is used for setting the gain of the receiver in 8 different gain stages (AMP1 to AMP8). **GAIN** should be set such that with a medium **POWER** value the sensor operates in its dynamic range (X,Y,Z between 2750 and 3750).

In **AC** mode, **GAIN** directly influences the scan frequency. The current scan frequency is displayed in the **SCOPE** tab.

GAIN only is available with **CALIB=OFF**.

AVERAGE:

This function field is used for adjusting the number of scanning values (measurement values) over which the raw signal measured at the receiver is averaged. A higher **AVERAGE** default value reduces noise of the raw signals at the receiver unit and there will be a decrease of the maximal available switching frequency of the sensor

INTEGRAL:

This function field is used to set the number of scan values (measurement values) over which the raw signal measured at the receiver is summed up. This integral function allows the reliable detection even of extremely weak signals. A higher **INTEGRAL** value increases the noise of the raw signals of the receiver unit, and simultaneously decreases the maximum achievable switching frequency of the sensor.

GAIN only is available with **CALIB=OFF**.

INFO:

The **POWER** slider, **GAIN** and **INTEGRAL** only are effective with **CALIB = OFF**.

Otherwise the sensor operates with the values set in calibration.

C SPACE L*a*b* CALIB OFF

C SPACE:

Selection of a color space (**COLOR SPACE**) for the calculation of the color stimulus specification.

x y Y:

The chromaticity values (chromaticity coordinates) **x**, **y** are calculated from the tristimulus values X, Y, Z. **x** and **y** define the color, and **Y** is used as a brightness reference (lightness variable).

Lightness variable	$Y = \frac{Y}{4096}$	
Chromaticity coordinates	$x = \frac{X}{X + Y + Z}$	$y = \frac{Y}{X + Y + Z}$
Color difference	$\Delta E^* = \sqrt{(\Delta x)^2 + (\Delta y)^2 + (\Delta Y)^2}$	

L*a*b*:

The L*a*b* color space (also referred to as the CIELAB space) is one of the uniform color spaces defined by the CIE in 1976.

Lightness variable	$L^* = 116 \left(\frac{Y}{Y_n}\right)^{1/3} - 16$	
Chromaticity coordinates	$a^* = 500 \left[\left(\frac{X}{X_n}\right)^{1/3} - \left(\frac{Y}{Y_n}\right)^{1/3} \right]$	$b^* = 200 \left[\left(\frac{Y}{Y_n}\right)^{1/3} - \left(\frac{Z}{Z_n}\right)^{1/3} \right]$
Color difference	$\Delta E^* = \sqrt{(\Delta L^*)^2 + (\Delta a^*)^2 + (\Delta b^*)^2}$	

L*u*v*:

The L*u*v* color space (also referred to as the CIELUV space) is one of the uniform color spaces defined by the CIE in 1976.

Lightness variable	$L^* = 116 \left(\frac{Y}{Y_n}\right)^{1/3} - 16$	
Chromaticity coordinates	$u^* = 13L^*(u' - u_n')$	$v^* = 13L^*(v' - v_n')$
	$u' = \frac{4X}{X + 15Y + 3Z} = \frac{4x}{3 - 2x + 12y}$	$v' = \frac{9Y}{X + 15Y + 3Z} = \frac{9y}{3 - 2x + 12y}$
	$u_n' = \frac{4X_n}{X_n + 15Y_n + 3Z_n} = \frac{4x_n}{3 - 2x_n + 12y_n}$	$v_n' = \frac{9Y_n}{X_n + 15Y_n + 3Z_n} = \frac{9y_n}{3 - 2x_n + 12y_n}$
Color difference	$\Delta E^* = \sqrt{(\Delta L^*)^2 + (\Delta u^*)^2 + (\Delta v^*)^2}$	

X Y Z	Tristimulus values XYZ of the specimen.
Xn Yn Zn	Tristimulus values of a perfect reflecting diffuser.
$\Delta L^* \Delta a^* \Delta b^*$	Difference in L*, a*, and b* values between the specimen color and the target color.
$\Delta L^* \Delta u^* \Delta v^*$	Difference in L*, u*, and v* values between the specimen color and the target color.
u' v'	Chromaticity coordinates from the CIE 1976 UCS diagram.
u'n v'n	Chromaticity coordinates of a perfect reflecting diffuser.

CALIB:

The sensors are factory-calibrated. If the **CALIB** parameter is set to **FCAL** (Factory **CAL**ibration), the sensor operates with this factory calibration.

As an alternative the user can himself calibrate the sensor to different surfaces (User **CAL**ibration).

If **CALIB=UCAL** is selected, the sensor operates with the calibration made by the user.

With **CALIB=OFF** the sensor operates in "uncalibrated" mode. In this mode the sensor is very fast. Both **FCAL** and **UCAL** will slow down the sensor.

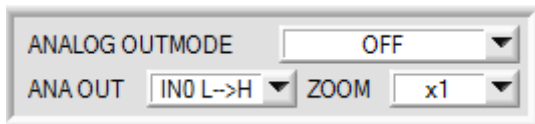

ANALOG OUTMODE:

This function field is used to determine the signals that the sensor provides at its analog outputs.

OFF: No analog signal is output.

X Y Z:

The tristimulus values **X**, **Y**, **Z** are acquired with 12 bit resolution.

The signals therefore may have values between 0 and 4095.

At the respective analog outputs these values are provided in a 0 to 10V range.

COLOR SPACE:

The color coordinates of the selected **C SPACE** are scaled to 12 bit and are output as a voltage from 0 to 10 V at the respective analog outputs.

CS REF:

When input IN0 is set to HI, the current **C SPACE** color coordinates are saved as 5 V reference values.

This means that when the respective current **C SPACE** color value is equal to the reference value, 5 V will be output at the corresponding analog output. If the current value deviates from the reference value, this deviation is output at the corresponding analog output starting from 5 V and amplified by the **ZOOM** factor.

Example: **ZOOM** = x4, **a***(reference) = 60, **a***(current) = 70 → deviation = 10 (1 digit is approx. 2.44mV)

Output: $5\text{ V} + (10\text{ digit} * 32\text{ (zoom)} * 2.44\text{ mV}) = \text{approx. } 5.78\text{ V}$.

The reference values are displayed in the graph window under the **C SPACE** tab.

Since the sensor only has one hardware input (IN0) this input possibility is not always available. If, for example, you select **ANA OUT = IN0 L->H**, the input already is used for a controlled output of the analog signal and is no longer available for **CS REF**.

Function fields that are not available will either be hidden or deactivated.

EVALUATION MODE

EVALUATION MODE:

In this function field the evaluation mode at the SPECTRO-3-MSM-ANA color sensor can be set.

EVALUATION MODE

FIRST HIT:

The currently measured color values are compared with the default values in the **TEACH TABLE**, starting with teach-color 0. If in the row-by-row comparison the current color values correspond with the teach-parameters entered in the TEACH TABLE, this first "hit" in the TEACH TABLE is displayed as a color number (**C-No.**) and is output at the digital outputs (OUT0 and OUT1) according to the settings of the **OUTMODE** parameter (see **OUTMODE**).

If the current color does not correspond with any of the teach-colors, the color code **C-No.** = 255 will be set ("error status").

Tip! This mode is used if only one color is taught, and this color must be checked to avoid "drifting away". With the rising tolerance windows this can be detected very well, and countermeasures can be initiated, if necessary.

Tip! Values can be entered in a cell of the table either by double-clicking on the respective cell, or by highlighting the respective cell and then pressing F2 .

Tip! The teach colors are only activated when the **SEND** button is pressed!

	a*	b*	L*	deltaE	
0	-12.46	-19.40	61.62	10.00	Red
1	-12.46	-19.40	61.62	15.00	Green
2	-12.46	-19.40	61.62	20.00	Blue

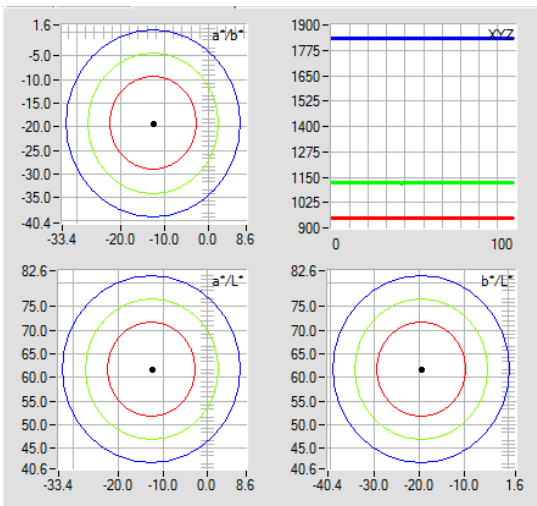

EVALUATION MODE

BEST HIT:

The currently measured color values are compared with the default values in the **TEACH TABLE**, starting with teach-color 0. If in the row-by-row comparison the current color values correspond with several of the teach parameters entered in the color table, the teach parameter that has the shortest distance from the current color value will be a hit.

This "hit" in the TEACH TABLE is displayed as a color number (**C-No.**) and is output at the digital outputs (OUT0 and OUT1) according to the settings of the **OUTMODE** parameter (see **OUTMODE**).

If the current color does not correspond with any of the teach-in colors, the color code **C-No.** = 255 will be set ("error status").

Tip! This mode is used if several colors must be separated from each other, and only certain surface fluctuations are allowed.

Tip! Since what you are looking for here with several "hits" is the shortest distance of the current color to the centres of the taught colors, the individual tolerance windows (circles) may overlap here. The sensor detects the **"best hit"**.

Tip! Values can be entered in a cell of the table either by double-clicking on the respective cell, or by highlighting the respective cell and then pressing F2.

Tip! The teach colors are only activated when the **SEND** button is pressed!

	a*	b*	L*	deltaE	
0	45.69	49.29	59.99	110.00	Red
1	-51.70	44.97	65.33	110.00	Green
2	-7.56	-11.97	54.32	110.00	Blue

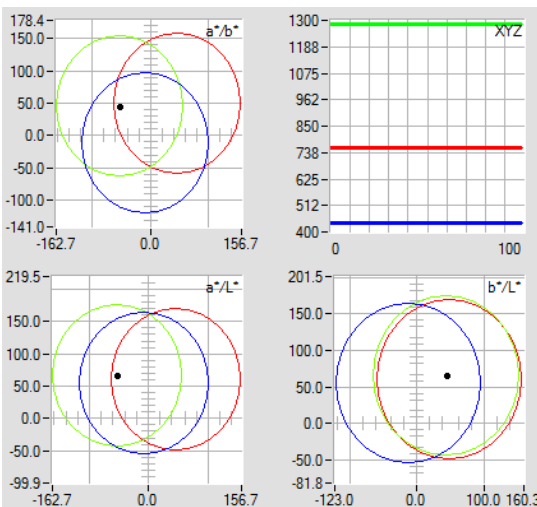

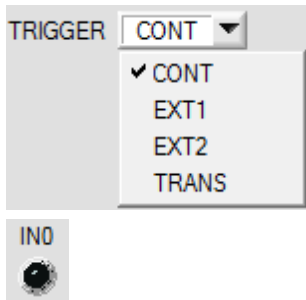

TRIGGER:

This function field serves for setting the trigger mode at the sensor. If **TRIGGER** is not **CONT**, the LED **IN0** shows a trigger event.

CONT: Continuous color detection (no trigger event required).

EXT1: Color detection is started through the external trigger input (IN0 pin3 green of cable cab-las8/SPS). A trigger event is recognized as long as +24V is present at the IN0 input (HIGH-active). After the trigger input goes to LOW again, the state (C-No.) that was last detected will be held at the outputs.

EXT2: Same behaviour as in EXT1 mode, with the difference that an error state (color no. = 255) will be output after the trigger input goes to LOW again.

TRANS:

Same behaviour as in **CONT**. However, in contrast to **CONT** in this mode the transmitter source will be switched off if no trigger event (IN0) is given.

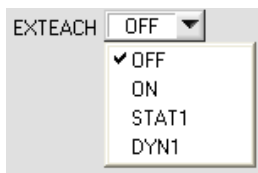

EXTEACH:

In all the evaluation modes teaching of a color can be performed externally through IN0.

OFF: The external TEACH feature is deactivated.

ON: The sensor can be taught up to 3 colors through IN0.

In **BEST HIT** evaluation mode teaching through IN0 can be performed to every individual row in the **TEACH TABLE**. With **FIRST HIT** the currently present color is taught to all the rows that are activated with **MAXCOL-No.**

Select the function **EXTERN TEACH = ON**.

Set the power such that the sensor is not overdriven and that the signal also is not too low.

Select how many colors you want to teach externally.

Click on the **TEACH** tab to change to the **TEACH TABLE**.

Then enter the respective tolerances for the colors you want to teach.

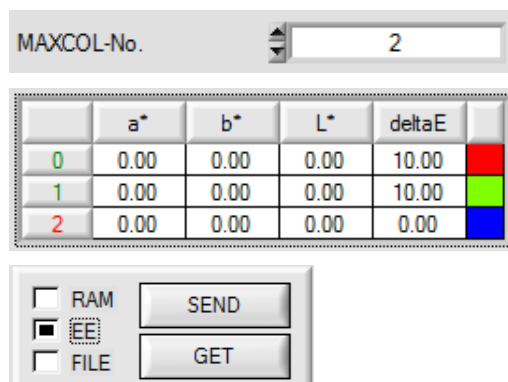

In this example **MAXCOL-No.** = 2 was selected. This means that the sensor should find the color information that is saved in the first 2 rows of the **TEACH TABLE** by way of external teaching through IN0. Since the sensor cannot calculate its **deltaE** tolerances itself, these values must be entered once (in this example 10 in all fields) and together with **MAXCOL-No.** and **EXTEACH = ON** must be saved in the **EEPROM**.

Then select **EE** in the function field, and click on **SEND**.

From now on, the PC is no longer necessary, as long as you only wish to teach colors up to the **MAXCOL-No.** and do not want to change the tolerances.

INFO:

Of course the taught colours can be viewed at any time with the PC.

Colors that are taught are stored in the **EEPROM** of the sensor, i.e. the information will not be lost when the system is turned off.

This function rather is intended for "after-teaching", because the sensor does not automatically adjust its **POWER** value.

EXTEACH=ON:

Before the external teach-process can be started, the color to be taught must be presented to the sensor. The external teach process is started with a positive edge at IN0 (green wire). The outputs OUT0 and OUT1 alternately change their state between 0V and 24V. From now on, the user has a certain number of seconds time to inform the sensor about the position at which the color information (**X Y INT** or **siM**) should be placed in the **TEACH TABLE**. The **BUSY** window is the time that the user has for informing the sensor about the teach rows. It depends on the value that is set in **MAXCOL-No.** (e.g. approx. 2 seconds when **MAXCOL-No.** = 2).

The first positive edge (start edge 0) selects position 0 in the **TEACH TABLE**. Every additional positive edge selects one position higher (see table below).

Example:

If you wish to save the current color to position 3 in the **TEACH TABLE**, the following steps have to be performed:

1. Start the external TEACH process with a positive edge (0) at IN0 → Position 0 is selected.
2. Another positive edge (1) selects position 1 in the TEACH TABLE.
3. Another positive edge (2) selects position 2 in the TEACH TABLE.
4. Another positive edge (3) selects position 3 in the TEACH TABLE.
5. The desired position is now selected.
6. When the **BUSY** window is over, the sensor starts the evaluation.
7. To teach another color → go to pos. 1

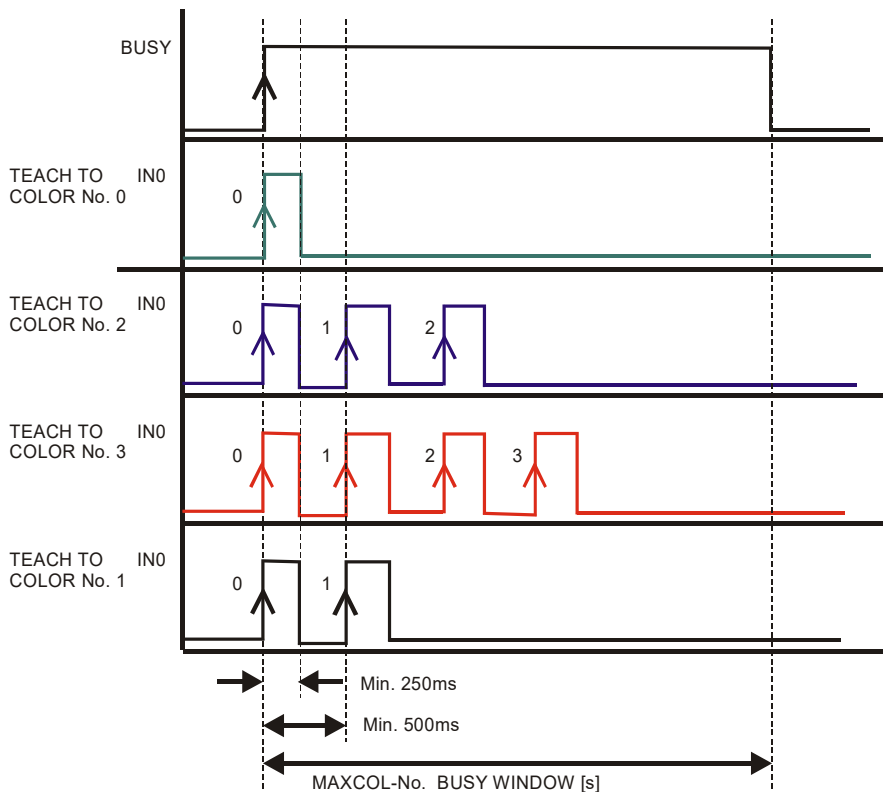

INTLIM

INTLIM:

An intensity limit can be set in this edit box. If the current intensity $(X+Y+Z)/3$ arriving at the receiver unit falls below this limit, color evaluation will no longer be performed, and an error state will be output.

Attention: ERROR STATE if: $(X+Y+Z)/3 < INTLIM$

MAXCOL-No.

MAXCOL-No.:

This function field serves for setting the number of colors to be checked.

With **OUTMODE = BINARY** a maximum of 3 colors can be taught.

With **OUTMODE = DIRECT HI** or **DIRECT LO** a maximum of 2 colors can be taught.

The numerical value set here determines the currently possible scanning rate of the color sensor. The less the colors to be checked, the faster the operation of the sensor. The numerical value set here refers to the number of rows (starting with row 0) in the **TEACH TABLE** (→ 2.4 Tab TEACH TABLE).

DIGITAL OUTMODE

DIGITAL OUTMODE:

This group of buttons offers the method of how to control the 2 digital outputs.

OFF:

No digital signal is output. All the corresponding function fields are hidden.

DIRECT:

In this mode the maximum number of colors to be taught is 2.

If in this row-by-row comparison the current color values correspond with the teach-in parameters entered in the TEACH TABLE, this color in the TEACH TABLE is displayed as a color number (C-No.) and is sent **direct** to the digital outputs (OUT0 and OUT1).

DIRECT HI:

If **DIRECT HI** is activated, the respective digital output is set to HIGH. If the current color does not correspond with any of the teach-in colors, all digital outputs are set to LOW.

DIRECT LO:

If **DIRECT LO** is activated, the specially digital output is set to LOW, while the other ones are set to HIGH. If the current color does not correspond with any of the teach-in colors, all digital outputs are set to HIGH.

BINARY HI:

If in the row-by-row comparison the current color values correspond with the teach-parameters entered in the color table, this "hit" in the color table is displayed as a color number (C-No.) and is provided at the digital outputs (OUT0 and OUT1) as a **bit pattern**.

A maximum of 3 colors can be taught.

BINARY LO:

Same function as **BINARY HI**, but the **bit pattern** is output inversely.

2.3 Graphical display elements

Tab XYZ:

Display of the current raw signals (tristimulus values) X, Y, Z of the 3-fold receiver.

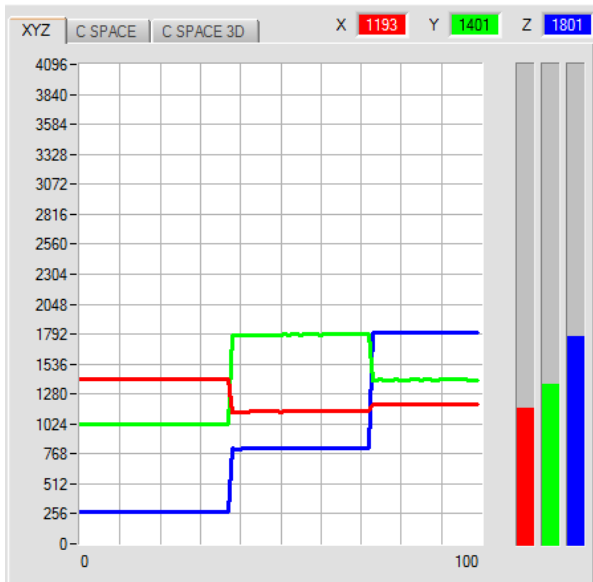

Tab C SPACE:

Line graph display of the color coordinates of the color space selected under C SPACE.



Tab C SPACE 3D:

Display of the taught color coordinates and of the current color position. For improved representation the color sphere in space is shown from three sides.

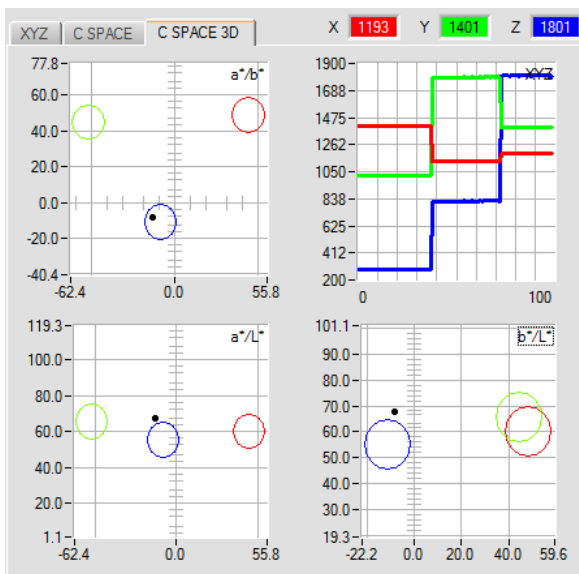

a*	u*	x
-12.98	-17.22	0.2645
b*	v*	y
-8.18	-15.34	0.3029
L*	L*	Y
67.63	54.01	0.2007

X or s:

These numerical value displays show the color coordinates and brightness values that are calculated from the tristimulus values **X, Y, Z**. Calculation is performed as described in **C SPACE**.

delta E
0.12

delta E:

This display shows the color distance from a color hit. Calculation is performed as described in **C SPACE**.

In **FIRST HIT** evaluation mode **delta E** is equal to the distance from a color hit. If there was no color hit, **delta E** is calculated in relation to the last valid color in the color table (depending on **MAXCOL-No.**)

In **BEST HIT** evaluation mode **delta E** also is equal to the distance from a color hit. However, if there was no color hit, **delta E** has the value -1.00.

This also applies if the current intensity $(X+Y+Z)/3$ falls below the **INTLIM** parameter.

C-No:
0

C-No.:

This numerical value output field shows the currently detected color number according to the entry in the **TEACH TABLE**. The currently detected color number is sent to the digital outputs OUT0 and OUT1 as a corresponding bit pattern.

A value of 255 means that none of the taught colors was detected.

A double-click on the display will open a larger display window.



IN0:

This LED display visualises the status of input IN0.

If 0 V is applied at the input, the LED is black.

If 24 V is applied at the input, the LED is green.

This display only is visible if the input is used.

TEMP	27
------	----

TEMP:

This display shows the temperature in the sensor housing.

The display does **NOT** show degrees Celsius or Fahrenheit.

Please note: The above-mentioned output fields are only updated when data transfer between PC and sensor is active (GO button pressed).

2.4 Tab TEACH

When the **GO** button is pressed, data transfer from the sensor to the PC is started. The tristimulus values **X**, **Y**, **Z** and the calculated color coordinates and brightness values are shown in the displays and in the graphic windows.

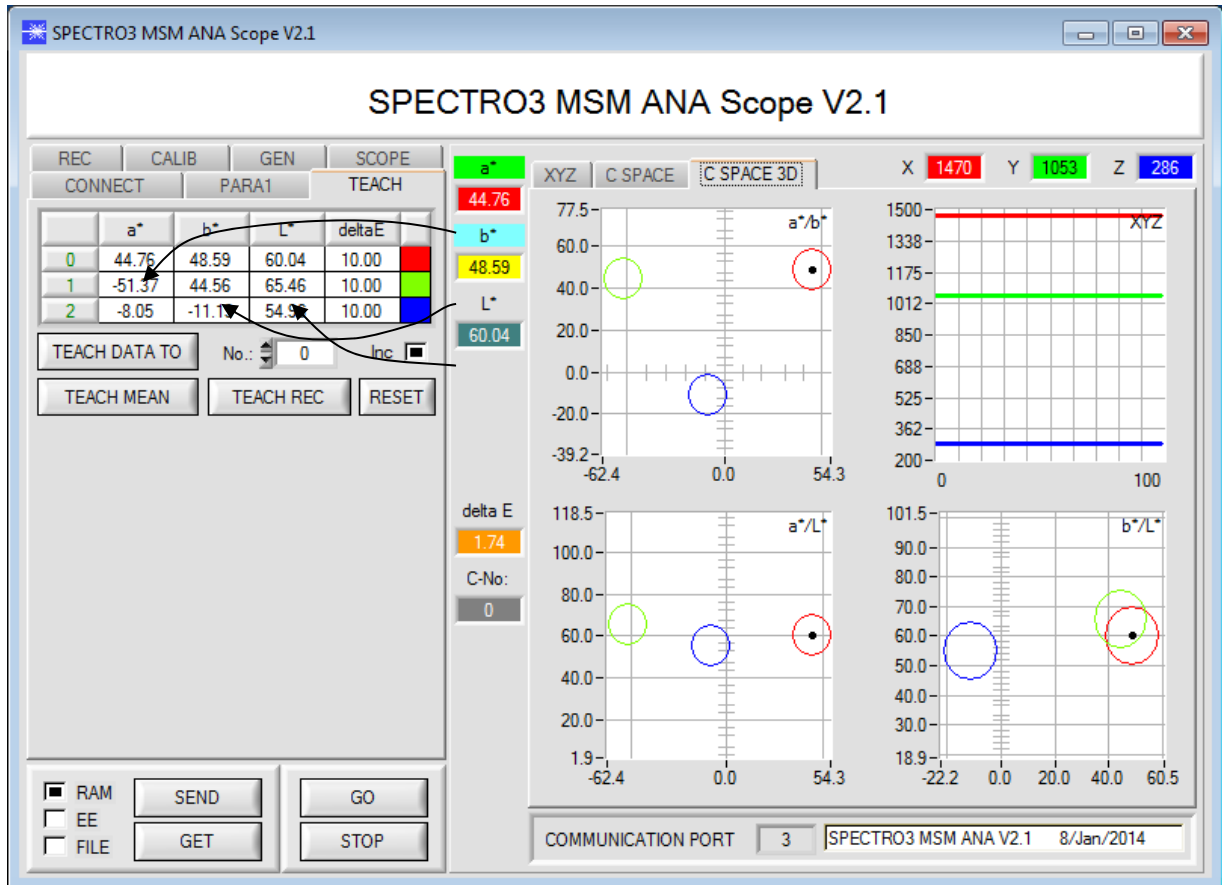

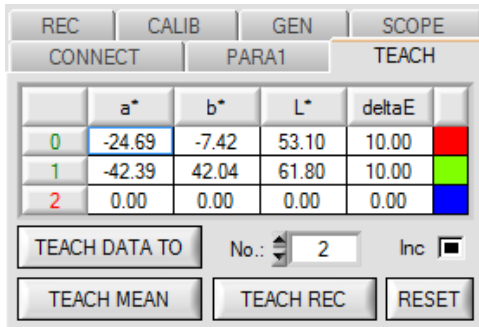

TEACH:

Click on the **TEACH** tab to open a window where you can teach colors to the **TEACH TABLE**.

Please note: The teach colors must be sent to the sensor by clicking on SEND.

The **TEACH TABLE** is organised in rows, i.e. the individual parameters for the teach colors are listed side by side in the respective row.

The sensor can work with up to 3 teach colors. The number of the respective teach color is shown in the left column of the table.

Only rows with a green number are used for evaluation by the

sensor. The number of rows to be used is defined with **MAXCOL-No.**

After a click on **TEACH DATA TO** the currently displayed color coordinates and the brightness value are written to the row in the **TEACH TABLE** that is selected under **No.:**. A color tolerance (**delta E**) also is defined. If necessary, the tolerances and the teach values can be changed by double-clicking on the respective field with the left mouse button (or by pressing F2) and then entering a numerical value with the PC keyboard.

If **Inc:** is activated and you click on the **TEACH DATA TO** button, the input field **No.:** will be automatically incremented (increased) by 1, i.e. the next row in the **TEACH TABLE** will be selected.

A click on **RESET TABLE** resets the **TEACH TABLE** (RESET value = 0).

	a*	b*	L*	deltaE	
0	-24.69	-7.42	53.10	12.00	Red
1	-42.39	42.04	61.80	12.00	Green
2	0.00	0.00	0.00	0.00	Blue

It is possible to edit several cells at the same time. For this purpose the cells that should be changed must be selected.

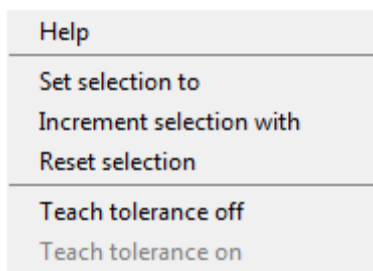

Right-click with the mouse to open a pop-up menu.

Use **Set selection to** if you wish to fill several cells in the **TEACH TABLE** with a certain value.

Use **Increment selection with** if you wish to enter increasing tolerance values.

The upper left cell is the starting value.

Starting from this cell the following cells will be increased by the value that is entered in the pop-up menu.

Use **Reset selection** to set the selected cells to 0.

When **TEACH DATA TO** is used the software suggests tolerance values and writes these values to the **deltaE** column.

This function can be switched on and off with **Teach tolerance off** and **Teach tolerance on**.

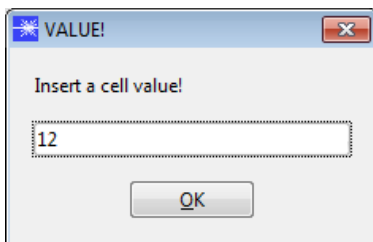

A click on **Help** will open a pop-up window that provides explanations of the individual functions.

The following panel will be displayed after a click on **TEACH MEAN VAL**.

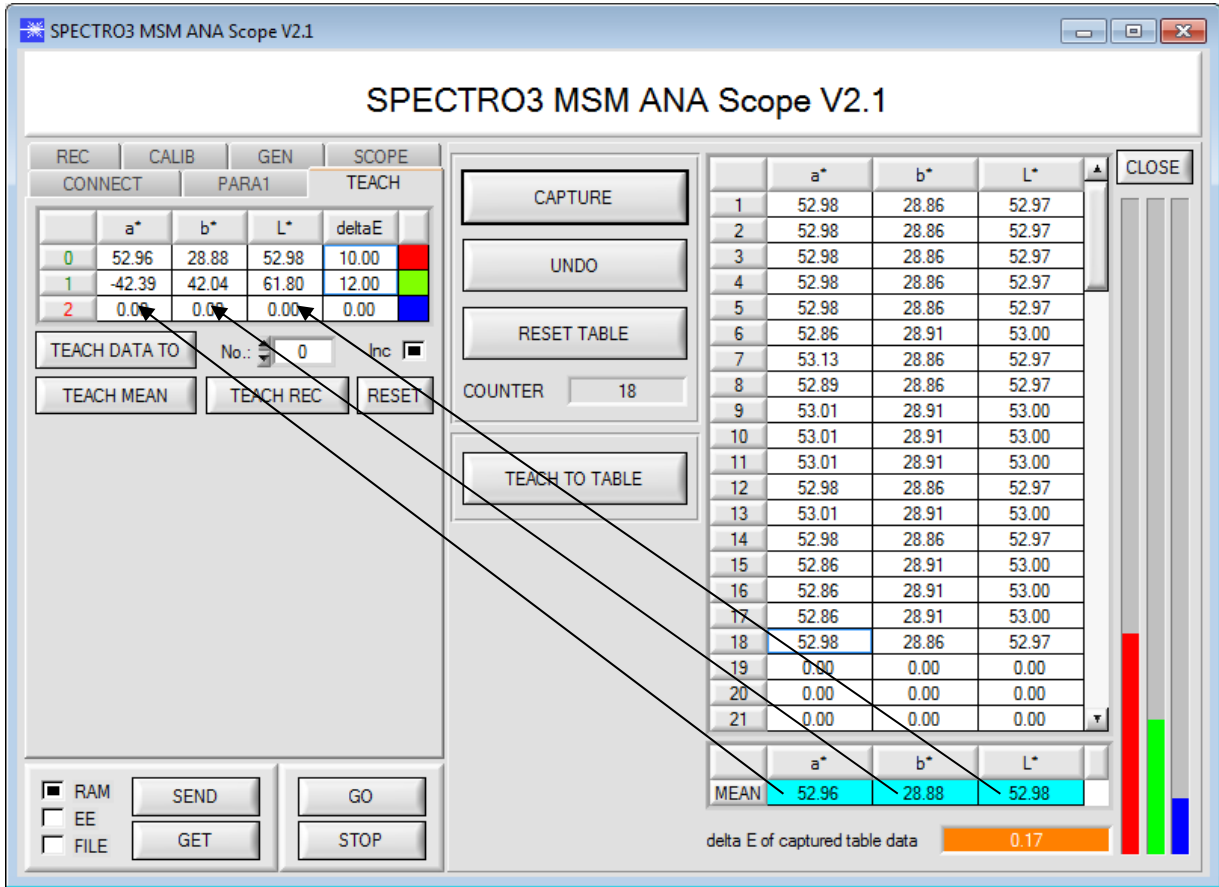

SPECTRO3 MSM ANA Scope V2.1

REC	CALIB	GEN	SCOPE	
CONNECT	PARA1	TEACH		
	a*	b*	L*	deltaE
0	52.96	28.88	52.98	10.00
1	-42.39	42.04	61.80	12.00
2	0.00	0.00	0.00	0.00

TEACH DATA TO No.: 0 Inc

TEACH MEAN TEACH REC RESET

COUNTER 18

TEACH TO TABLE

	a*	b*	L*
1	52.98	28.86	52.97
2	52.98	28.86	52.97
3	52.98	28.86	52.97
4	52.98	28.86	52.97
5	52.98	28.86	52.97
6	52.86	28.91	53.00
7	53.13	28.86	52.97
8	52.89	28.86	52.97
9	53.01	28.91	53.00
10	53.01	28.91	53.00
11	53.01	28.91	53.00
12	52.98	28.86	52.97
13	53.01	28.91	53.00
14	52.98	28.86	52.97
15	52.86	28.91	53.00
16	52.86	28.91	53.00
17	52.86	28.91	53.00
18	52.98	28.86	52.97
19	0.00	0.00	0.00
20	0.00	0.00	0.00
21	0.00	0.00	0.00
MEAN	52.96	28.88	52.98

delta E of captured table data 0.17

After a click on **GO**, data are automatically obtained from the sensor and displayed.

A click on the **CAPTURE** button enters a parameter frame in the table.

The **COUNTER** display field shown how many frames have already been recorded.

The last frames that were entered in the table can be deleted again by pressing **UNDO**.

RESET TABLE sets the whole table back to 0.

After every activation of **CAPTURE**, **UNDO**, or **RESET TABLE**, the mean values for the individual parameters are calculated automatically and are displayed in the mean value table.

Furthermore, a maximum color tolerance **delta E** is formed with respect to the mean values.

When the **TEACH TO TABLE** button is pressed, the respective mean values are taught to the row in the **TEACH TABLE** that is selected under **No.:**.

A click on the **CLOSE** button will take you back to the main panel.

A click on the button **TEACH REC VAL** (teach recorded values) opens a panel which, after a click on the **START** button, starts to record data and display them in the three graphs. This function is useful if the material to be detected cannot be directly placed in front of the sensor, for example because it is transported on a conveyor belt that cannot be stopped or cannot be exactly stopped at the position required for teaching. After some time, area centres will become apparent that can be assumed to be the objects to be taught. The screenshot below shows 3 of these positions.

After a click on **STOP** the cursor can then be positioned on such an area centre in any of the graphs. The cursor will be automatically positioned in the other two graphs.

With **TEACH TO TABLE** the current cursor position can then be transferred to the **TEACH TABLE**. Teaching will be performed to the row that is set under **No.:**.

RESET can be used to reset the graphs and the counter.

CLOSE takes you back to the main panel.

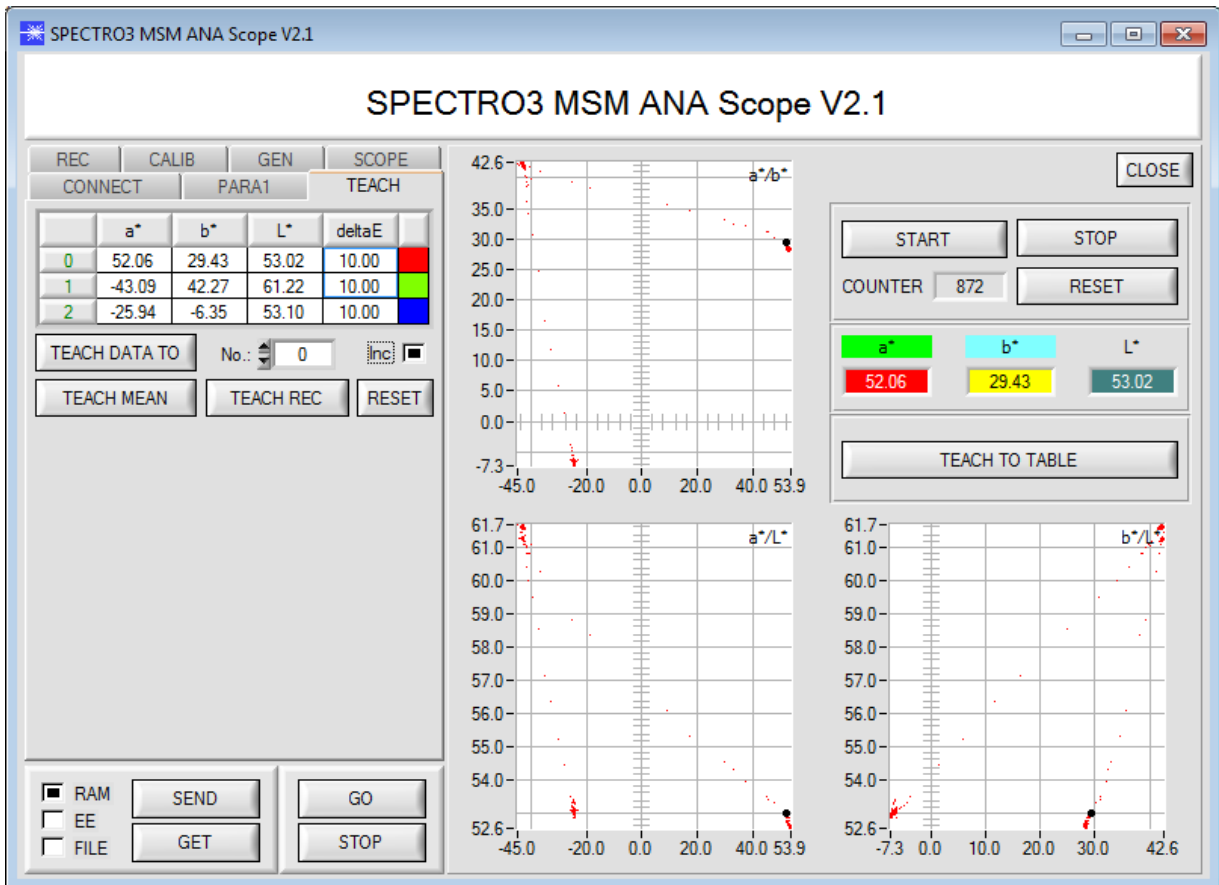

2.5 Tab GEN

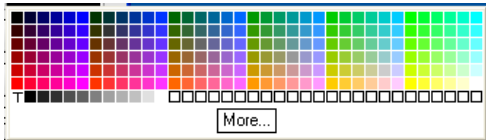
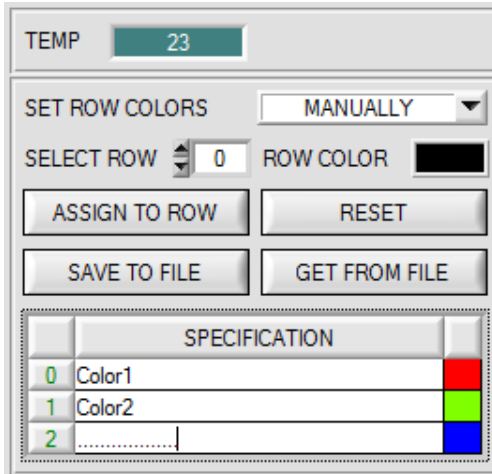

GEN:

A click on **GEN** opens a display of the current temperature value **TEMP** in the sensor housing.

The display is **NOT** in degrees Celsius or Fahrenheit.

In the GEN tab you also can manually select the row colors in which the individual tolerance circles are displayed, or let the system set these colors automatically based on the colors detected by the system.

Furthermore, designations for the individual rows can be entered in the **SPECIFICATION** table. These designations are saved on the PC's hard disk and can be loaded again, if necessary.

If **SET ROW COLOR** is set to **MANUALLY**, the row color that should be changed must be set under **SELECT ROW**.

A click on the colored area of **SELECT COLOR** opens a color palette where the desired color can be selected.

After a click on the **SET** button, the color will be displayed in the 6th column and the selected row of the **TEACH TABLE**.

If **SET ROW COLOR** is set to **AUTOMATICALLY**, the system will automatically calculate the corresponding row color, display the color in a color display beside the graph and, after a click on **TEACH DATA TO**, automatically insert it in the corresponding row.

The **SAVE TO FILE** and **GET FROM FILE** functions allow you to save specified row color arrays and the **SPECIFICATION** table on the hard disk, or to load previously saved arrays.

A click on **RESET** resets the colors to a default value.

When the software is started again, the **ROW COLOR** table and the **SPECIFICATION** table that were active when the software was closed are automatically loaded again.

2.6 Tab REC

The SPECTRO3-MSM-ANA-Scope software includes a data recorder that makes it possible to save the data acquired and calculated by the sensor with a time stamp. The recorded file is saved to the hard disk of the PC and can then be evaluated with a spreadsheet program.

The following steps describe how data frames are recorded with the recorder:

Step 1:

When the **REC** button is pressed, the following window will be displayed:

When the **SHOW GRAPH** button is pressed, a panel will be displayed that allows the user to monitor the different signals.

The individual signals can be activated from the **SIGNAL** drop-down menu.

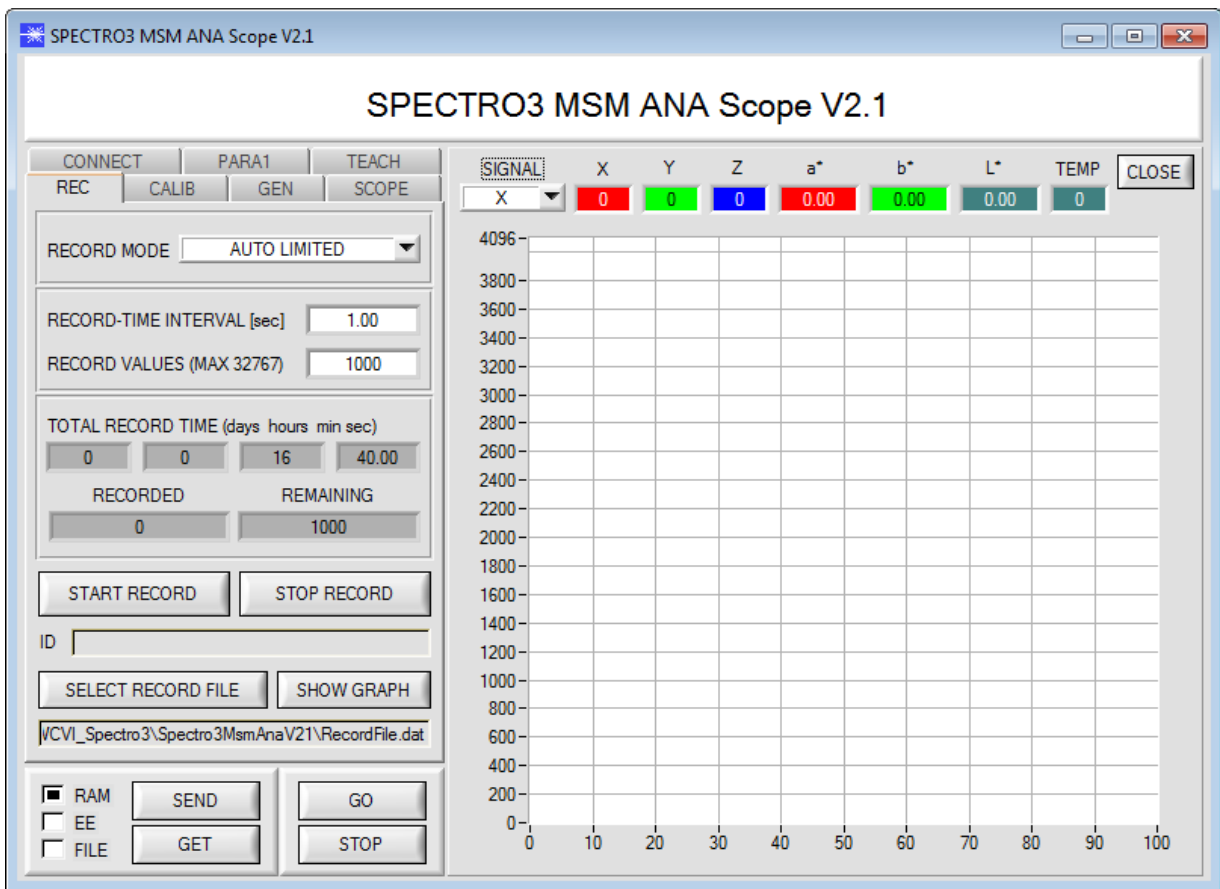

RECORD MODE AUTO LIMITED ▼			
RECORD-TIME INTERVAL [sec]	1.00		
RECORD VALUES (MAX 32767)	1000		
TOTAL RECORD TIME (days hours min sec)			
0	0	16	40.00
RECORDED		REMAINING	
0		1000	
START RECORD		STOP RECORD	
ID <input style="width: 100%;" type="text"/>			
SELECT RECORD FILE		SHOW GRAPH	
d:\Mist\RecordFile.dat			

Step 2:

If you want to automatically record several data frames, please select **AUTO LIMITED** under **RECORD MORE**. Enter a time interval for recording under **RECORD-TIME INTERVAL [sec]**, in this example: 1, i.e. a new value is called from the sensor every second). Then enter the maximum number of values you wish to record in the **RECORD VALUES [MAX 32767]** field. Please note: Recording can also be stopped earlier by clicking **STOP RECORD**, the data recorded so far will not be lost.

The **TOTAL RECORD TIME** field indicates how long recording will take (in days, hours, minutes, and seconds) if all data are recorded.

Step 3:

By pressing the button **SELECT RECORD FILE** a file can be selected in which the data frame will be stored.

If you select an already existing file name, you will be asked whether you want to overwrite the existing file or not.

Step 4:

Pressing the **START RECORD** button starts automatic data recording.

The recorder starts to record data, and the button **START RECORD** is red to indicate that recording is active. The respective data frames are shown in the display windows.

In the two display fields **RECORDED** and **REMAINING** you can check how many data frames have been recorded, and how many frames remain to be recorded.

Please note:

During recording the two input fields RECORD-TIME INTERVAL and VALUES TO BE RECORDED are inactive.

Step 5:

When as many data frames as set under **RECORD VALUES [MAX 32767]** have been recorded, or when the **STOP AUTO RECORD** button is pressed, a pop-up window will appear which confirms that the file is stored.

If you want to record an unlimited number of data, select the **AUTO UNLIMITED** function under **RECORD MORE**. Then select the desired recording interval and press **START RECORD**.

If you want to record data "manually", select the **MANUAL RECORDING** function under **RECORD MORE**. You can start reading data from the sensor by pressing the **GO** button. These data are visualised in the display window. Pressing the **CAPTURE DATA FRAME** button saves a data frame in the file that was selected under **SELECT RECORD FILE**. The **RECORDED** field shows the sum of the frames already recorded.

If **AUTO TRIGGERED** is selected under **RECORD MORE**, and **TRIGGER = EXT1, EXT2, or TRANS** is selected, the sensor will automatically send a data frame after each drop of the trigger when **START RECORD** is pressed. This data frame is captured and recorded by the recorder. Pressing the **STOP RECORD** button terminates the automatic sending function of the sensor again.

Please note:

When you press START RECORD, the file that is selected under SELECT RECORD FILE will be deleted. With RECORD FRAME MANUALLY, the file will be created if it does not already exist. If the file already exists, the data are added to the existing file.

2.7 Tab CALIB

2.7.1 Calibration

The sensors are factory-calibrated. If the **CALIB** parameter is set to **FCAL** (Factory **CAL**ibration), the sensor operates with this factory calibration.



As an alternative the user can himself calibrate the sensor to different surfaces (User **CAL**ibration).

If **CALIB=UCAL** is selected, the sensor operates with the calibration made by the user.

Calibration is performed by using different surfaces with known color coordinates and brightness values. A ColorChecker™ table is available as an alternative. This table has 24 color fields according to the CIE STANDARD.

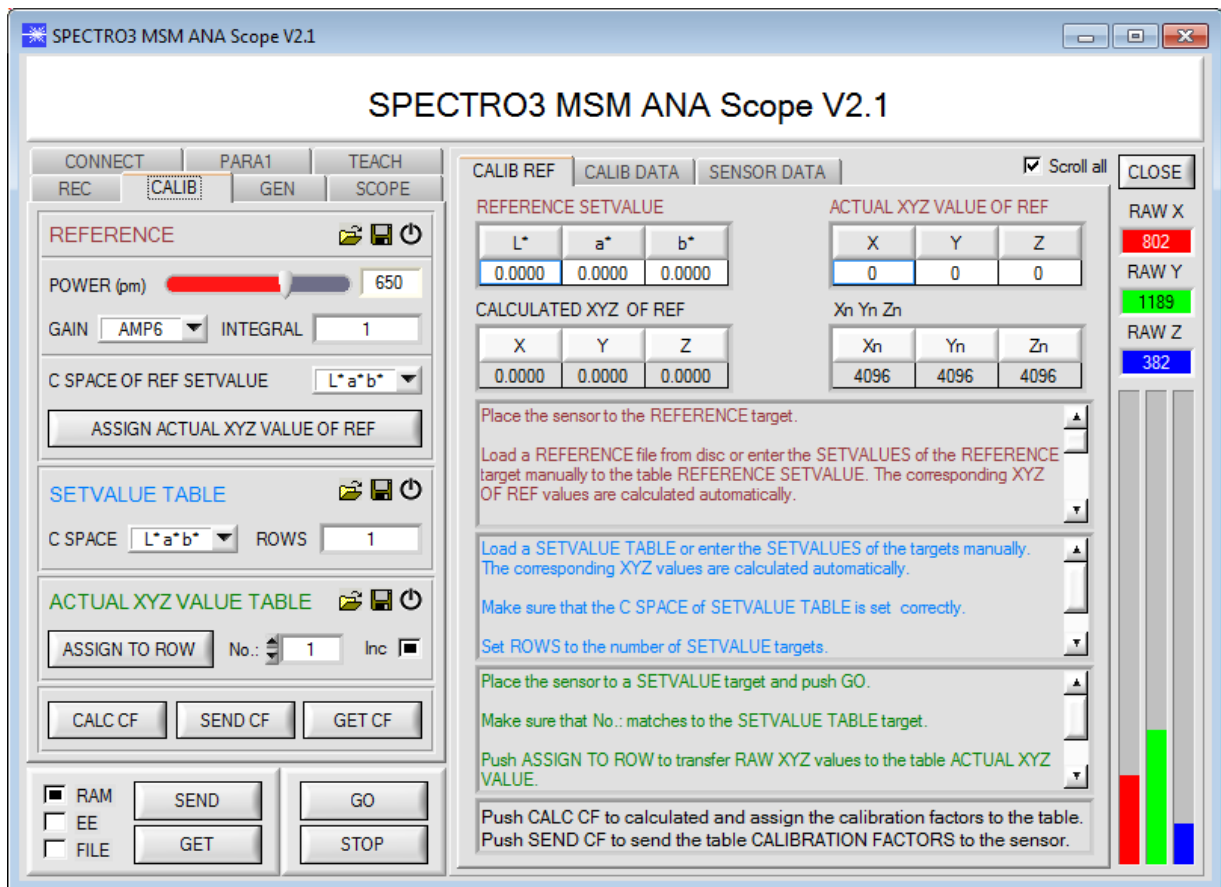
A click on **CALIB** will open the following window:



REFERENCE   

POWER (pm)  650

GAIN AMP6 INTEGRAL 1

C SPACE OF REF SETVALUE L*a*b*



ASSIGN ACTUAL XYZ VALUE OF REF

REFERENCE SETVALUE			ACTUAL XYZ VALUE OF REF		
L*	a*	b*	X	Y	Z
96.0000	-0.0600	0.0600	3169	3366	3326
CALCULATED XYZ OF REF			Xn Yn Zn		
X	Y	Z	Xn	Yn	Zn
85.5205	90.0078	97.9271	3554	3739	4072

Please perform the following steps in sequence:

- Place a white reference surface before the sensor.
- Click on **GO** to start data exchange between sensor and PC software.
- The color coordinates and the brightness value of the reference surface must be known and must be entered in the **REFERENCE SETVALUE** table. The corresponding tristimulus values **X, Y, Z** are calculated automatically and are written to the **CALCULATED XYZ OF REF** table.
- It is important to select the correct color space **C SPACE OF REF SETVALUE**.
- **POWER, GAIN, and INTEGRAL** must be set such that the highest signal of **RAW X, Y, Z** is approx. 3000 digits.
- With **ASSIGN ACTUAL XYZ VALUE OF REF** the tristimulus values **RAW X, Y, Z** acquired by the sensor are written to the **ACTUAL XYZ VALUE OF REF** table, and the tristimulus values **Xn, Yn, Zn** of a completely matt white body are calculated automatically.
- **Xn, Yn, Zn** are needed for calculating the color coordinates and the brightness value in almost all color spaces.

Use the file and disk symbol if you want to write the REFERENCE settings to a file or read them from a file. A click on the reset symbol will reset the tables.

SETVALUE TABLE   

C SPACE L*a*b* ROWS 24

SETVALUE TABLE

	L*	a*	b*
1	38.0800	12.0900	14.3900
2	66.3800	13.2200	17.1400
3	51.0600	0.3800	-22.0600
4	43.3000	-16.5200	21.4600
5	56.3600	12.8400	-25.2900
6	71.6000	-30.7100	1.1700
7	61.7000	27.5400	58.2300
8	41.2200	17.9500	-43.1600
9	51.5700	43.0000	14.7500
10	30.7700	25.7400	-23.3800

CALCULATED XYZ SETVALUES

	X	Y	Z
1	11.2090	10.1330	6.6737
2	37.9900	35.8172	26.5196
3	18.4366	19.3204	35.5269
4	10.3918	13.3595	7.1758
5	26.0397	24.2729	45.9869
6	31.7370	43.0664	45.8178
7	36.2076	30.0531	5.9134
8	14.0848	12.0024	38.8245
9	28.3959	19.7646	14.3397
10	8.9339	6.5543	15.3201

Several different surfaces are needed for sensor calibration.

The number of surfaces must be entered in **ROWS**.



The color coordinates and brightness values must be known.

These must be entered in the **SETVALUE TABLE**.

The corresponding color space must be selected under **C SPACE**.

The corresponding tristimulus values **X, Y, Z** are calculated automatically and are written to the **CALCULATED XYZ SETVALUES** table.

Use the file and disk symbol if you want to write the **SETVALUE** settings to a file or read them from a file. A click on the reset symbol will reset the tables.

ACTUAL XYZ VALUE TABLE   

ASSIGN TO ROW No.: Inc

ACTUAL XYZ VALUE TABLE

	X	Y	Z
1	394	345	248
2	1290	1224	913
3	641	760	1173
4	389	454	237
5	853	911	1488
6	1166	1633	1492
7	1313	929	293
8	467	518	1338
9	901	607	524
10	280	248	495

CALIBRATION FACTORS

	X	Y	Z
1	1089	1124	1030
2	1127	1120	1112
3	1101	973	1159
4	1022	1126	1159
5	1168	1020	1183
6	1042	1009	1175
7	1055	1238	772
8	1154	887	1110
9	1206	1246	1047
10	1221	1011	1184

Now the surfaces corresponding with the **SETVALUES** must be placed before the sensor.

With **ASSIGN TO ROW** the tristimulus values **RAW X, Y, Z** that are currently determined by the sensor are written to the row in the **ACTUAL XYZ VALUE TABLE** that is selected under **No.:**.

The calibration factors that are determined from the tables **CALCULATED XYZ SETVALUES** and **ACTUAL XYZ VALUE TABLE** are written to the **CALIBRATION FACTORS** table.

Use the file and disk symbol if you want to write the **ACTUAL XYZ VALUE TABLE** to a file or read it from a file. A click on the reset symbol will reset the tables.

With a click on the **CALC CF** button the calibration factors that are determined from the tables **CALCULATED XYZ SETVALUES** and **ACTUAL XYZ VALUE TABLE** are written to the **CALIBRATION FACTORS** table.

SEND CF will save the tables **ACTUAL XYZ VALUE TABLE** and **CALIBRATION FACTORS** in the EEPROM of the sensor.

A click on **GET CF** will display the tables saved in the sensor and the reference parameters in the **SENSOR DATA** tab.

2.7.2 Offset calibration

To avoid an increase of the electronic offset when using the integral function (**INTEGRAL** parameter), this offset can be eliminated by way of offset calibration or zero-point calibration. The corresponding tab is password-protected to prevent inadvertent incorrect settings.

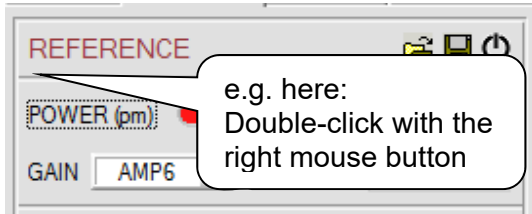

Offset calibration can be accessed by double-clicking with the right mouse button exactly at any frame in the **CALIB** tab.

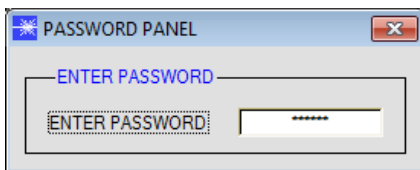

You will then be prompted to enter a password. The password is: mellon

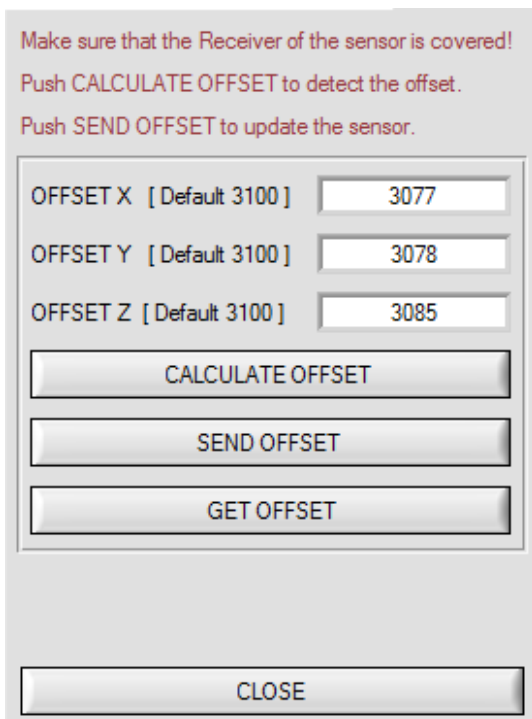

Now please follow the instructions provided in the tab.

ATTENTION!

It is extremely important for offset calibration that the receiver is not exposed to any extraneous light. Please make sure that you cover the receiver of the sensor e.g. with a black cloth that is impervious to light.

This is absolutely necessary for proper offset calculation.

Now press **CALCULATE OFFSET**. The offset values for red, green, and blue should be approximately 3080 plus/minus 40.

The offset values can then be sent to the sensor by pressing **SEND OFFSET**.

GET OFFSET can be used to check whether the data have been sent.

2.8 Tab SCOPE

The SCOPE tab visualises an oscilloscope.

Depending on **TRIG MODE**, the display shows the **XYZ** signals, the color space, the output analog signal (depending on the **ANA OUT** settings), and the status of the digital outputs.

A click on **GET CYCLE TIME** displays the current sensor scan frequency in [Hz] and [ms]. The current scan frequency must be determined for the correct calculation of **deltaX[ms]**. For determining the correct scan frequency please give the sensor a time of 8 seconds before you click on **GET CYCLE TIME**.

In **TRIG MODE = SINGLE SHOT** a data frame is recorded and displayed in the graph when you click on **SCAN**.

In **TRIG MODE = FALLING EDGE** and **RIISING EDGE** triggered recording can be started by clicking on **SCAN**. A trigger start can be defined with **TRIGGER LEVEL**.

Triggering is performed either to **Z** or to the brightness value of the color space, depending on the signal that should be recorded. In the graph this is the blue line.

In **TRIG MODE = INTERN C-No.0** recording starts automatically when C-No. 0 is detected. **TRIG MODE= EXTERN IN0** can be used to start recording externally through input IN0.

SCAN-RATE can be used to delay or accelerate recording. This corresponds with the TIMEBASE function known in oscilloscopes. **PRE TRIGGER VALUES** can be used to define how many values should still be displayed before the actual trigger start.

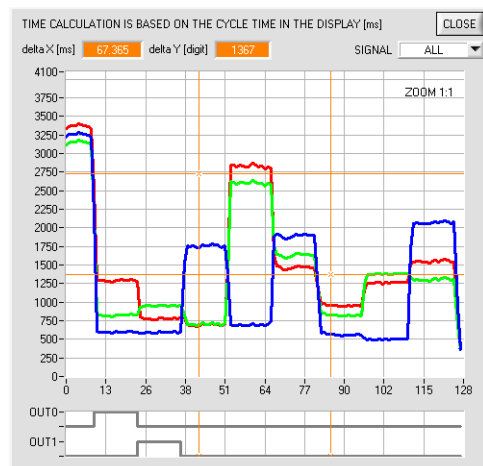
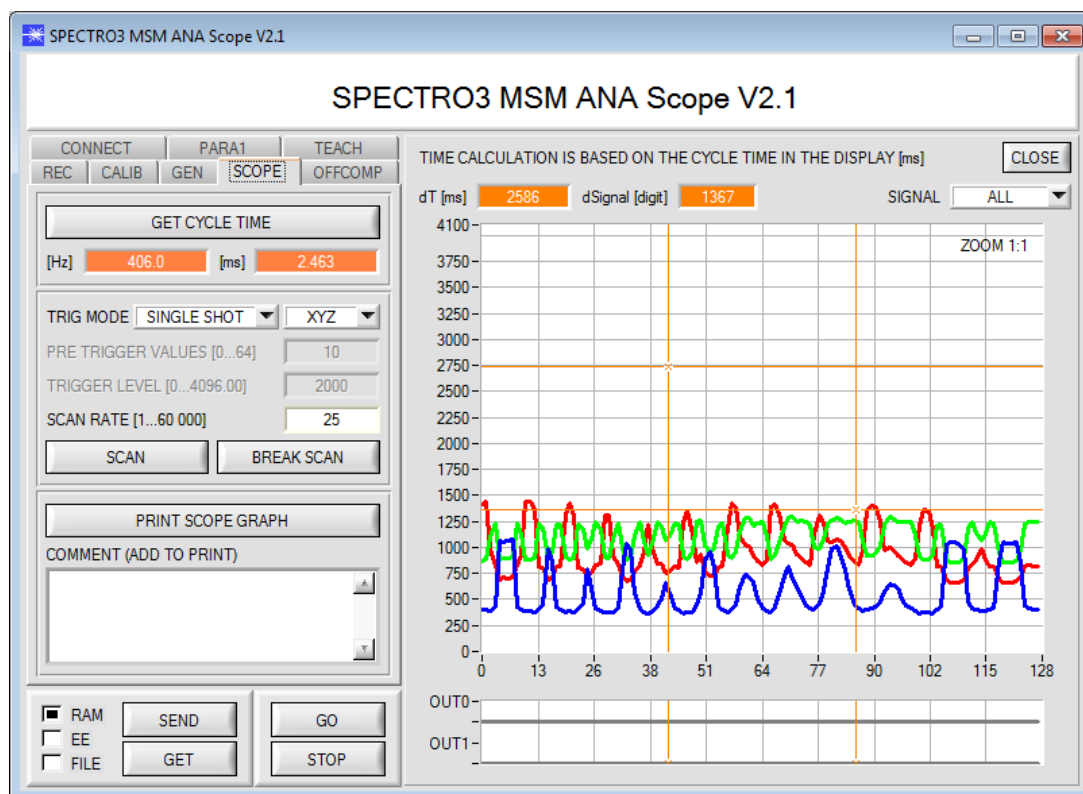

The zoom function in the graph can be activated by holding the control key (CTRL) and drawing a window with the mouse.

A click on **ZOOM 1:1** cancels the zoom function again.

The two orange cursors can be moved with the mouse. The two displays **deltaX[ms]** and **deltaY[digit]** will be updated. **deltaX[ms]** shows the time between the cursors in X direction.

deltaY[digit] shows the difference between the two cursors in digits or in Volt in Y direction.

SIGNAL can be used to display individual curves.

PRINT SCOPE GRAPH prints the current screen together with the text in the **COMMENT** text field.

3. Operation of the TEMPCOMP-Scope software

If a firmware update should go wrong and the temperature characteristics that are stored in the EEPROM should be lost, these characteristics must be created anew. For this purpose you will need a file with the corresponding data. This file can be obtained from your supplier.

To perform temperature compensation please start the corresponding **TEMPCOMP-Scope software** that is included on the supplied CD. Please make sure that you have a functioning sensor connection. It may be necessary to select the connection with **CONNECT**. Set the correct sensor under **SELECT SENSOR**, if this is not done automatically.

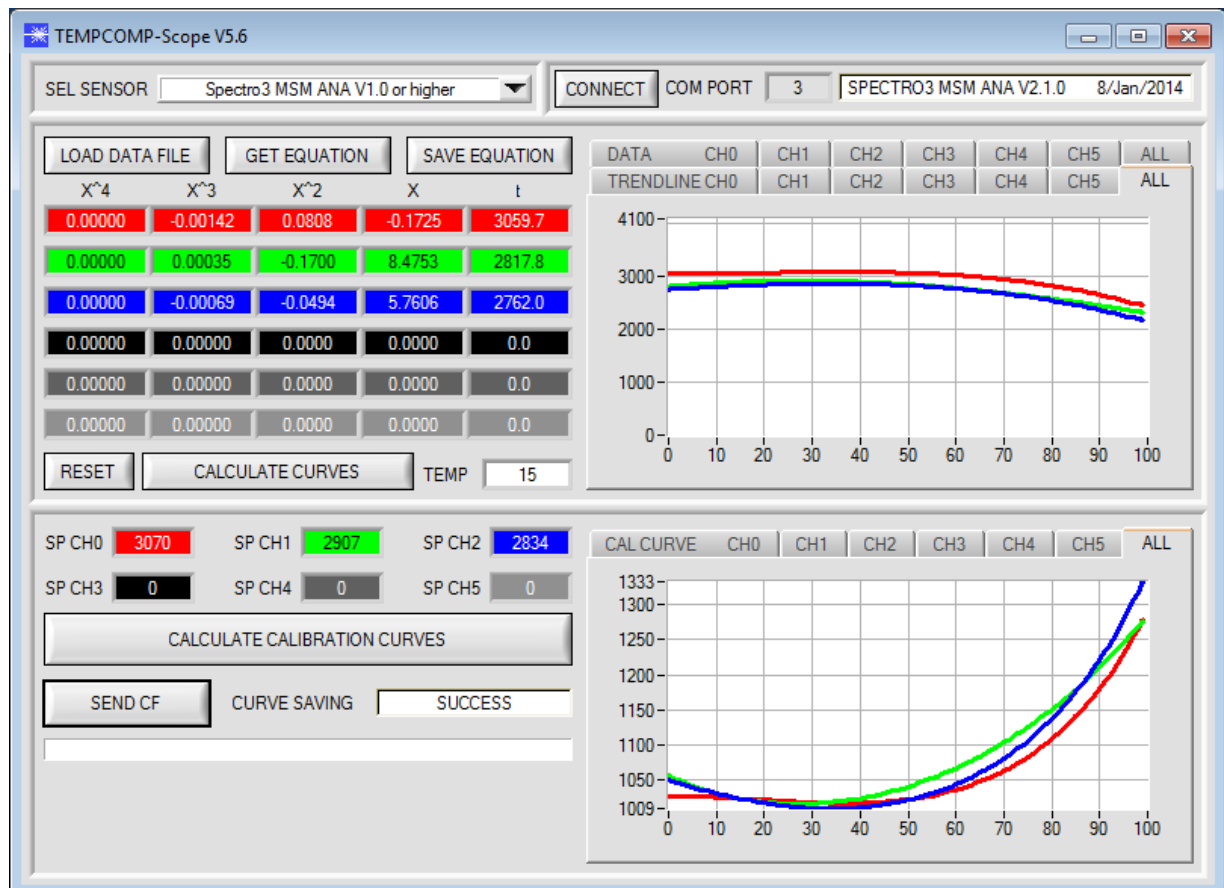

- Step 1: Load the temperature compensation file that you have received from your supplier with **GET EQUATION** or **LOAD DATA FILE**.
- Step 2: Press **CALCULATE CURVES** to display the data in the graph.
- Step 3: Select the sensor-internal operating temperature (not in °C) that the sensor has at an ambient temperature of 20°, if this has not already been done automatically. The value should be included in the file designation.
- Step 4: Press **CALCULATE CALIBRATION CURVES** to calculate the mean straight line.
- Step 5: Pressing the **SEND CF** button saves the mean straight lines in the **EEPROM** of the sensor.
- Step 6: Temperature compensation is successfully finished if the **SUCCESS** status message is then displayed.

Comment! If you do not immediately have the temperature compensation file at hand, simply start the **TempComp-Scope software**. Establish a connection, if it is not already established, and simply press **SEND-CF**. The sensor then functions as before, but it is not temperature-compensated.

4. External triggering of the SPECTRO-3-MSM-ANA color sensor

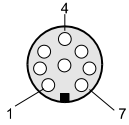

External triggering is performed through pin no. 3 (grn) at the 8-pole socket of the SPECTRO-3-MSM-ANA/PLC connection.

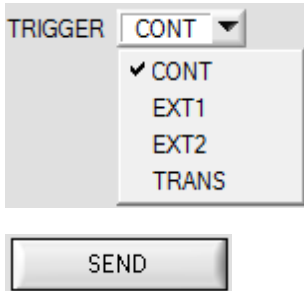

TRIGGER:

First the external trigger mode must be set at the color sensor. For this purpose option **EXT1**, **EXT2**, or **TRANS** must be selected in the **TRIGGER** selection field.

PLEASE NOTE:

The new setting is only activated at the sensor after a click on the **SEND** button!

Please note: The trigger input (IN0 PIN3 green of cable cab-las8/SPS) is HIGH-active, i.e. a trigger event is detected as long as IN0 = HIGH (+24V).

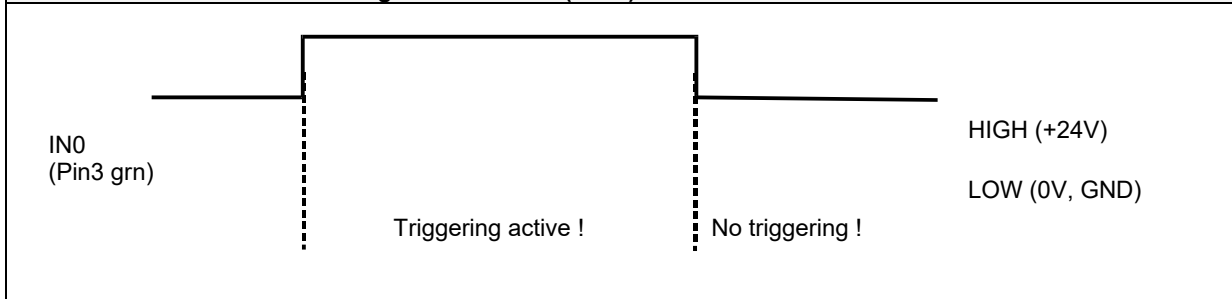

5. Connector assignment of the SPECTRO-3-MSM-ANA color sensor

Connection of SPECTRO-3-MSM-ANA to PC:

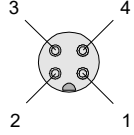
4-pole fem. M5 connector (type Binder 707) SPECTRO-3-MSM-ANA/PC-RS232		 
Pin-No.:		Assignment:
1		+24VDC (+Ub)
2		0V (GND)
3		Rx0
4		Tx0

Connection of SPECTRO-3-MSM-ANA to PLC:

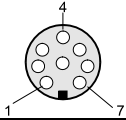
8-pole female connector (type Binder 712) SPECTRO-3-MSM-ANA/PLC		 
Pin No.:	Color:	Assignment:
1	White	0V (GND)
2	Brown	+24VDC ($\pm 10\%$) (+Ub)
3	Green	IN0
4	Yellow	OUT0 (Digital 0: typ. 0 ... 1V, Digital 1: typ. +Ub – 10%)
5	Grey	OUT1 (Digital 0: typ. 0 ... 1V, Digital 1: typ. +Ub – 10%)
6	Pink	OUT2 (Analog 0 ... +10V)
7	Blue	OUT3 (Analog 0 ... +10V)
8	Red	OUT4 (Analog 0 ... +10V)

6. RS232 communication protocol

The sensors of the SPECTRO-3-MSM-ANA series operate with the following **parameters** that are sent to the sensor or read from the sensor in the stated sequence.

Info! 1 **bytes** = 8bit 1 **word** = 2 **byte** 1 **long** = 2 **word** = 4 **byte**

Parameter	Type	Meaning
Para1: POWER	word	Transmitter intensity (0 ... 1000) Attention intensity in thousandth!
Para2: AVERAGE	word	Signal averaging 1, 2, 4, 8, 16, 32, 64, 128, 256, 512, 1024, 2048, 4096, 8192, 16384 or 32768
Para3: EVALUATION MODE	word	Evaluation mode: FIRST HIT, BEST HIT coded to (0,1)
Para4: INTLIM	word	Intensity limit (0 ... 4095)
Para5: MAXCOL-No.	word	Number of the colours (1,2,3)
Para6: DIGITAL OUTMODE	word	Function of the digital output: OFF, DIRECT HI, DIRECT LO, BINARY HI, BINARY LO coded to (0,1,2,3,4)
Para7: TRIGGER	word	Trigger mode: CONT, EXT1, EXT2, TRANS coded to (0, 1, 2, 3)
Para8: EXTEACH	word	External teach mode: OFF, ON, STAT1, DYN1 coded to (0,1,2,3)
Para9: C SPACE	word	Color Space: xyY, L*a*b*, L*u*v* coded to (0,1,2)
Para10: CALIB	word	Calibration Mode: OFF, FCAL, UCAL coded to (0,1,2)
Para11: LED MODE	word	Control for the internal light source DC, AC coded to (0,1)
Para12: GAIN	word	Amplification of the integrated receiver AMP1, AMP2, AMP3, AMP4, AMP5, AMP6, AMP7, AMP8 coded to (1, 2, 3, 4, 5, 6, 7, 8)
Para13: INTEGRAL	word	Signal integration (1...250)
Para14: ANALOG OUTMODE	word	Function of the analogue outmode: OFF, X Y Z, COLOR SPACE, CS REF coded to (0,1,2,3)
Para15: ANA OUT	word	Function of analogue out: CONT, IN0 L--->H coded to (0,1)
Para16: ANA ZOOM	word	Zoom factor at ANALOG OUTMODE = CS REF: x1, x2, x4, x8, x16, x32, x64, x128 Coded to (0,1,2,3,4,5,6,7)

One row in the Teach Table determines a **TEACH VECTOR**.

The sensors of the SPECTRO-3-MSM-ANA series operate with 3 **TEACH VECTORS** that are sent to the sensor or read from the sensor in one block in the stated sequence.

Info! 1 **bytes** = 8bit 1 **word** = 2 **byte** 1 **long** = 2 **word** = 4 **byte**

TEACH VECTOR	Type	Meaning
TeachVal1: Teach Table Row 0 Column 0	long	x, a*, u* of row 0. Must be multiplied with 65536.
TeachVal2: Teach Table Row 0 Column 1	long	y, b*, v* of row 0. Must be multiplied with 65536.
TeachVal3: Teach Table Row 0 Column 2	long	Y, L*, L* of row 0. Must be multiplied with 65536.
TeachVal4: Teach Table Row 0 Column 3	long	Tolerance delta E of row 0. Must be multiplied with 65536.
TeachVal5: Free	word	Send 0 as dummy
TeachVal6: Free	word	Send 0 as dummy
TeachVal7: Free	word	Send 0 as dummy
TeachVal8: Free	word	Send 0 as dummy
TeachVal9: Free	word	Send 0 as dummy
TeachVal10: Free	word	Send 0 as dummy
TeachVal11: Free	word	Send 0 as dummy
TeachVal11: Free	word	Send 0 as dummy
TeachVal12: Teach Table Row 1 Column 0	long	x, a*, u* of row 1. Must be multiplied with 65536.
TeachVal13: Teach Table Row 2 Column 1	long	y, b*, v* of row 1. Must be multiplied with 65536.
TeachVal14: Teach Table Row 3 Column 2	long	Y, L*, L* of row 1. Must be multiplied with 65536.
TeachVal15: Teach Table Row 4 Column 3	long	Tolerance delta E of row 1. Must be multiplied with 65536.
TeachVal16: Free	word	Send 0 as dummy
TeachVal17: Free	word	Send 0 as dummy
...
TeachVal36 Free	word	Send 0 as dummy

Upon request, the data acquired and processed by the sensor are sent by the sensor in the following sequence.
 Info! 1 **bytes** = 8bit 1 **word** = 2 **byte** 1 **long** = 2 **word** = 4 **byte**

DATA VALUE		Type	Meaning
DatVal1:	CSX	long	Color Space X chromaticity coordinate (x or a* or u*). Must be divided by 65536.
DatVal2:	CSY	long	Color Space Y chromaticity coordinate (y or b* or v*). Must be divided by 65536.
DatVal3:	CSI	long	Color Space Lightness variable (Y or L* or L*). Must be divided by 65536.
DatVal4:	REF CSX	long	Reference CSX when ANALOG OUTMODE = CS REF. Must be divided by 65536.
DatVal5:	REF CSY	long	Reference CSY when ANALOG OUTMODE = CS REF. Must be divided by 65536.
DatVal6:	REF CSI	long	Reference CSI when ANALOG OUTMODE = CS REF. Must be divided by 65536.
DatVal7:	delta E	long	Color difference to a color hit. Must be divided by 65536.
DatVal8:	X	word	Calibrated and temperature compensated tristimulus value of channel X
DatVal9:	Y	word	Calibrated and temperature compensated tristimulus value of channel Y
DatVal10:	Z	word	Calibrated and temperature compensated tristimulus value of channel Z
DatVal11:	RAW X	word	None Calibrated tristimulus value of channel X
DatVal12:	RAW Y	word	None Calibrated tristimulus value of channel Y
DatVal13:	RAW Z	word	None Calibrated tristimulus value of channel Z
DatVal14:	C-No:	word	Detected color
DatVal15:	DIG IN	word	DIG IN is 1 when input IN0 is HI
DatVal16:	TEMP	word	Temperature in the sensor (not in °C or °F)

Digital serial communication is used for the exchange of data between the software running on the PC and the sensor.

For this purpose the control unit features an EIA-232 compatible interface that operates with the (fixed) parameters **"8 data bits, 1 stop bit, no parity bit, no handshake"**.

Five values are available for the baudrate: 9600baud, 19200baud, 38400baud, 57600baud and 115200baud. As an option the PC software also can communicate through TCP/IP or USB. In these cases transparent interface converters must be used that allow a connection to the RS232 interface.

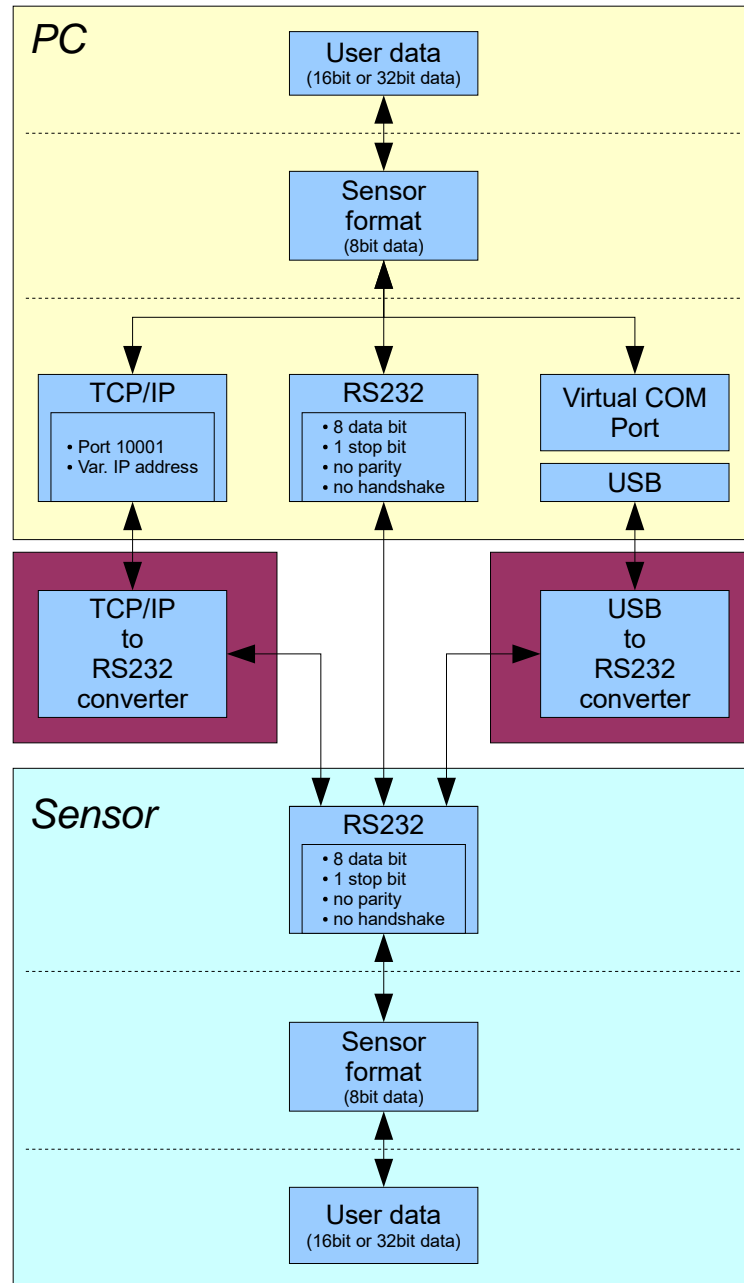

A proprietary protocol format that organises and bundles the desired data is used for all physical connection variants between PC software and control unit. Depending on their type and function the actual data are 16- or 32-bit variables and represent integer or floating-point values. The protocol format consists of 8-bit wide unsigned words ("bytes"). The actual data therefore sometimes must be distributed to several bytes.

The control unit always behaves passively (except if another behaviour has been specifically activated). Data exchange therefore always is initiated by the PC software. The PC sends a data package ("frame") corresponding to the protocol format, either with or without appended data, to which the control unit responds with a frame that matches the request.

The protocol format consists of two components:

A "header" and an optional appendant ("data").

The header always has the same structure.

The first byte is a synchronisation byte and always is 85_{dez} (55_{hex}).

The second byte is the so-called order byte. This byte determines the action that should be performed (send data, save data, etc.).

A 16-bit value (argument) follows as the third and fourth byte. Depending on the order, the argument is assigned a corresponding value.

The fifth and sixth byte again form a 16-bit value. This value states the number of appended data bytes. Without appended data both these bytes are 0_{dez} or 00_{hex}, the maximum number of bytes is 512.

The seventh byte contains the CRC8 checksum of all data bytes (data byte 0 up to and incl. data byte n).

The eighth byte is the CRC8 checksum for the header and is formed from bytes 0 up to and incl. 6.

The header always has a total length of 8 bytes. The complete frame may contain between 8 and 520 bytes.

Byte0 Header	Byte1 Header	Byte2 Header	Byte3 Header	Byte4 Header	Byte5 Header	Byte6 Header	Byte7 Header	Byte8 Data	Byte9 Data	...	Byte n+6 Data	Byte n+7 Data
0x55	<order>	<ARG> (lo byte)	<ARG> (hi byte)	<LEN> (lo byte)	<LEN> (hi byte)	CRC8 (Data)	CRC8 (Header)	Data1 (lo byte)	Data1 (hi byte)	...	Data n/2 (lo byte)	Data n/2 (hi byte)

The following **orders** can be sent to the sensor.

Number	ORDER (header byte no. 2)	Example
0	Sensor answers with order=0 if a communication error occurs. ARG=1: Invalid order number was sent to the sensor ARG=2: General communication error (wrong baudrate, overflow, ...)	
1	Write parameter to the RAM of the sensor	order=1
2	Read parameter from the RAM of the sensor	order=2
3	Load parameter and actual Baudrate from RAM to EEPROM of the sensor	order=3
4	Load parameter from EEPROM to RAM of the sensor	order=4
5	Read CONNECTION OK and serial number from sensor	order=5
6	Free	
7	Read Firmware String and serial number from sensor	order=7
8	Read data values from sensor	order=8
30	Start and Stop triggered sending of data frames	order=30
105	Get cycle time from sensor	order=105
190	Write new baud rate to the sensor	order=190

CRC8 checksum

The so-called "Cyclic Redundancy Check" or CRC is used to verify data integrity. This algorithm makes it possible to detect individual bit errors, missing bytes, and faulty frames. For this purpose a value - the so-called checksum - is calculated over the data (bytes) to be checked and is transmitted together with the data package. Calculation is performed according to an exactly specified method based on a generator polynomial. The length of the checksum is 8 bit (= 1 byte). The generator polynomial is:

$$X^8+X^5+X^4+X^0$$

To verify the data after they have been received, CRC calculation is performed once again. If the sent and the newly calculated CRC values are identical, the data are without error.

The following pseudo code can be used for checksum calculation:

calcCRC8 (data[], table[])

Input: data[], n data of unsigned 8bit

table[], 256 table entries of unsigned 8bit

Output: crc8, unsigned 8bit

```

crc8 := AAhex
for I := 1 to n do
    idx := crc8 EXOR data[ i ]
    crc8 := table[ idx ]
endfor
return crc8

```

table[]

0	94	188	226	97	63	221	131	194	156	126	32	163	253	31	65
157	195	33	127	252	162	64	30	95	1	227	189	62	96	130	220
35	125	159	193	66	28	254	160	225	191	93	3	128	222	60	98
190	224	2	92	223	129	99	61	124	34	192	158	29	67	161	255
70	24	250	164	39	121	155	197	132	218	56	102	229	187	89	7
219	133	103	57	186	228	6	88	25	71	165	251	120	38	196	154
101	59	217	135	4	90	184	230	167	249	27	69	198	152	122	36
248	166	68	26	153	199	37	123	58	100	134	216	91	5	231	185
140	210	48	110	237	179	81	15	78	16	242	172	47	113	147	205
17	79	173	243	112	46	204	146	211	141	111	49	178	236	14	80
175	241	19	77	206	144	114	44	109	51	209	143	12	82	176	238
50	108	142	208	83	13	239	177	240	174	76	18	145	207	45	115
202	148	118	40	171	245	23	73	8	86	180	234	105	55	213	139
87	9	235	181	54	104	138	212	149	203	41	119	244	170	72	22
233	183	85	11	136	214	52	106	43	117	151	201	74	20	246	168
116	42	200	150	21	75	169	247	182	232	10	84	215	137	107	53

Example order=1: Write parameter to the RAM of the sensor.
 <ARG> determines whether you want to save parameter or teach vectors:
 ARG = 0 --> Parameter Set
 ARG = 2 --> Teach Vector Set

DATA FRAME PC → Sensor for Parameter Set 0

Byte0 Header	Byte1 Header	Byte2 Header	Byte3 Header	Byte4 Header	Byte5 Header	Byte6 Header	Byte7 Header	Byte8 Data	Byte9 Data	Byte10 Data	Byte11 Data
0x55	<order>	<ARG> (lo byte)	<ARG> (hi byte)	<LEN> (lo byte)	<LEN> (hi byte)	CRC8 (Data)	CRC8 (Header)	Para1 (lo byte)	Para1 (hi byte)	Para2 (lo byte)	Para2 (hi byte)
85 (dec)	1	0	0	32	0	161	84	138	2	0	2
ARG=0				LEN=32				Para1=650		Para2=512	

Byte12 Data	Byte13 Data	Byte14 Data	Byte15 Data	Byte16 Data	Byte17 Data	Byte18 Data	Byte19 Data	Byte20 Data	Byte21 Data	Byte22 Data	Byte23 Data
Para3 (lo byte)	Para3 (hi byte)	Para4 (lo byte)	Para4 (hi byte)	Para5 (lo byte)	Para5 (hi byte)	Para6 (lo byte)	Para6 (hi byte)	Para7 (lo byte)	Para7 (hi byte)	Para8 (lo byte)	Para8 (hi byte)
1	0	0	0	2	0	1	0	0	0	0	0
Para3=1		Para4=0		Para5=2		Para6=1		Para7=0		Para8=0	

Byte24 Data	Byte25 Data	Byte26 Data	Byte27 Data	Byte28 Data	Byte29 Data	Byte30 Data	Byte31 Data	Byte32 Data	Byte33 Data	Byte34 Data	Byte35 Data
Para9 (lo byte)	Para9 (hi byte)	Para10 (lo byte)	Para10 (hi byte)	Para11 (lo byte)	Para11 (hi byte)	Para12 (lo byte)	Para12 (hi byte)	Para13 (lo byte)	Para13 (hi byte)	Para14 (lo byte)	Para14 (hi byte)
1	0	0	0	0	0	6	0	1	0	1	0
Para9=1		Para10=0		Para11=0		Para12=6		Para13=1		Para14=1	

Byte36 Data	Byte37 Data	Byte38 Data	Byte39 Data
Para15 (lo byte)	Para15 (hi byte)	Para16 (hi byte)	Para16 (hi byte)
1	0	8	0
Para15=0		Para16=0	

DATA FRAME PC → Sensor for Teach Vector Set 0

Byte0 Header	Byte1 Header	Byte2 Header	Byte3 Header	Byte4 Header	Byte5 Header	Byte6 Header	Byte7 Header	Byte8 Data	Byte9 Data	Byte10 Data	Byte11 Data
0x55	<order>	<ARG> (lo byte)	<ARG> (hi byte)	<LEN> (lo byte)	<LEN> (hi byte)	CRC8 (Data)	CRC8 (Header)	Teach Val1 (byte0)	Teach Val1 (byte1)	Teach Val1 (byte2)	Teach Val1 (byte3)
85 (dec)	1	2	0	96	0	219	96	0	0	0	0
ARG=2				LEN=96				Teach Val1=0			

Byte12 Data	Byte13 Data	Byte14 Data	Byte15 Data	Byte16 Data	Byte17 Data	Byte18 Data	Byte19 Data	Byte20 Data	Byte21 Data	Byte22 Data	Byte23 Data
Teach Val2 (byte0)	Teach Val2 (byte1)	Teach Val2 (byte2)	Teach Val2 (byte3)	Teach Val3 (byte0)	Teach Val3 (byte1)	Teach Val3 (byte2)	Teach Val3 (byte3)	Teach Val4 (byte0)	Teach Val4 (byte1)	Teach Val4 (byte2)	Teach Val4 (byte3)
0	0	0	0	0	0	0	0	0	0	0	0
Teach Val2=0		Teach Val3=0		Teach Val4=0		Teach Val5=0		Teach Val6=0		Teach Val7=0	

Byte24 Data	Byte25 Data	Byte26 Data	Byte27 Data	Byte28 Data	Byte29 Data	Byte30 Data	Byte31 Data	Byte32 Data	Byte33 Data
Teach Val5 (lo byte)	Teach Val5 (hi byte)	Teach Val6 (lo byte)	Teach Val6 (hi byte)	Teach Val7 (lo byte)	Teach Val7 (hi byte)	Teach Val8 (lo byte)	Teach Val8 (hi byte)	Teach Val9 (lo byte)	Teach Val9 (hi byte)
0	0	0	0	0	0	0	0	0	0
TeachVal5=0		TeachVal6=0		TeachVal7=0		TeachVal8=0		TeachVal9=0		...	

DATA FRAME Sensor → PC

Byte0 Header	Byte1 Header	Byte2 Header	Byte3 Header	Byte4 Header	Byte5 Header	Byte6 Header	Byte7 Header
0x55	<order>	<ARG> (lo byte)	<ARG> (hi byte)	<LEN> (lo byte)	<LEN> (hi byte)	CRC8 (Data)	CRC8 (Header)
85 (dec)	1	0	0	0	0	170	224
ARG=0				LEN=0			

If you receive an argument greater than 0, ARG parameter where out of range and have been set to a default value.

Example order=2: Read parameter from the RAM of the sensor.
 <ARG> determines whether you want to read parameter or teach vectors:
 ARG = 0 --> Parameter Set
 ARG = 2 --> Teach Vector Set

DATA FRAME PC → Sensor

Byte0 Header	Byte1 Header	Byte2 Header	Byte3 Header	Byte4 Header	Byte5 Header	Byte6 Header	Byte7 Header
0x55	<order>	<ARG> (lo byte)	<ARG> (hi byte)	<LEN> (lo byte)	<LEN> (hi byte)	CRC8 (Data)	CRC8 (Header)
85 (dec)	2	0	0	0	0	170	185
ARG=0				LEN=0			

DATA FRAME Sensor → PC

Byte0 Header	Byte1 Header	Byte2 Header	Byte3 Header	Byte4 Header	Byte5 Header	Byte6 Header	Byte7 Header	Byte8 Data	Byte9 Data	Byte10 Data	Byte11 Data
0x55	<order>	<ARG> (lo byte)	<ARG> (hi byte)	<LEN> (lo byte)	<LEN> (hi byte)	CRC8 (Data)	CRC8 (Header)	Para1 (lo byte)	Para1 (hi byte)	Para2 (lo byte)	Para2 (hi byte)
85 (dec)	2	0	0	32	0	161	13	138	2	0	2
ARG=0				LEN=32				Para1=650		Para2=512	

Byte12 Data	Byte13 Data	Byte14 Data	Byte15 Data	Byte16 Data	Byte17 Data	Byte18 Data	Byte19 Data	Byte20 Data	Byte21 Data	Byte22 Data	Byte23 Data
Para3 (lo byte)	Para3 (hi byte)	Para4 (lo byte)	Para4 (hi byte)	Para5 (lo byte)	Para5 (hi byte)	Para6 (lo byte)	Para6 (hi byte)	Para7 (lo byte)	Para7 (hi byte)	Para8 (lo byte)	Para8 (hi byte)
1	0	0	0	2	0	1	0	0	0	0	0
Para3=1		Para4=0		Para5=2		Para6=1		Para7=0		Para8=0	

Byte24 Data	Byte25 Data	Byte26 Data	Byte27 Data	Byte28 Data	Byte29 Data	Byte30 Data	Byte31 Data	Byte32 Data	Byte33 Data	Byte34 Data	Byte35 Data
Para9 (lo byte)	Para9 (hi byte)	Para10 (lo byte)	Para10 (hi byte)	Para11 (lo byte)	Para11 (hi byte)	Para12 (lo byte)	Para12 (hi byte)	Para13 (lo byte)	Para13 (hi byte)	Para14 (lo byte)	Para14 (hi byte)
1	0	0	0	0	0	6	0	1	0	1	0
Para9=1		Para10=0		Para11=0		Para12=6		Para13=1		Para14=1	

Byte36 Data	Byte37 Data	Byte38 Data	Byte39 Data
Para15 (lo byte)	Para15 (hi byte)	Para16 (hi byte)	Para16 (hi byte)
1	0	8	0
Para15=0		Para16=0	

Example order=3: Load parameter and actual Baudrate from RAM to EEPROM of the sensor.

DATA FRAME PC → Sensor

Byte0 Header	Byte1 Header	Byte2 Header	Byte3 Header	Byte4 Header	Byte5 Header	Byte6 Header	Byte7 Header
0x55	<order>	<ARG> (lo byte)	<ARG> (hi byte)	<LEN> (lo byte)	<LEN> (hi byte)	CRC8 (Data)	CRC8 (Header)
85 (dec)	3	0	0	0	0	170	142
ARG=0				LEN=0			

• DATA FRAME Sensor → PC

Byte0 Header	Byte1 Header	Byte2 Header	Byte3 Header	Byte4 Header	Byte5 Header	Byte6 Header	Byte7 Header
0x55	<order>	<ARG> (lo byte)	<ARG> (hi byte)	<LEN> (lo byte)	<LEN> (hi byte)	CRC8 (Data)	CRC8 (Header)
85 (dec)	3	0	0	0	0	170	142
ARG=0				LEN=0			

Example order=4: Load parameter from EEPROM to RAM of the sensor.

DATA FRAME PC → Sensor

Byte0 Header	Byte1 Header	Byte2 Header	Byte3 Header	Byte4 Header	Byte5 Header	Byte6 Header	Byte7 Header
0x55	<order>	<ARG> (lo byte)	<ARG> (hi byte)	<LEN> (lo byte)	<LEN> (hi byte)	CRC8 (Data)	CRC8 (Header)
85 (dec)	4	0	0	0	0	170	11
ARG=0			LEN=0				

DATA FRAME Sensor → PC

Byte0 Header	Byte1 Header	Byte2 Header	Byte3 Header	Byte4 Header	Byte5 Header	Byte6 Header	Byte7 Header
0x55	<order>	<ARG> (lo byte)	<ARG> (hi byte)	<LEN> (lo byte)	<LEN> (hi byte)	CRC8 (Data)	CRC8 (Header)
85 (dec)	4	0	0	0	0	170	11
ARG=0			LEN=0				

Example order=5: Read CONNECTION OK from sensor.

DATA FRAME PC → Sensor

Byte0 Header	Byte1 Header	Byte2 Header	Byte3 Header	Byte4 Header	Byte5 Header	Byte6 Header	Byte7 Header
0x55	<order>	<ARG> (lo byte)	<ARG> (hi byte)	<LEN> (lo byte)	<LEN> (hi byte)	CRC8 (Data)	CRC8 (Header)
85 (dec)	5	0	0	0	0	170	60
ARG=0			LEN=0				

DATA FRAME Sensor → PC

ARG determines the serial number of the sensor

Byte0 Header	Byte1 Header	Byte2 Header	Byte3 Header	Byte4 Header	Byte5 Header	Byte6 Header	Byte7 Header
0x55	<order>	<ARG> (lo byte)	<ARG> (hi byte)	<LEN> (lo byte)	<LEN> (hi byte)	CRC8 (Data)	CRC8 (Header)
85 (dec)	5	170	0	0	0	170	178
ARG=170			LEN=0				

Example order=7: Read Firmware String from sensor

DATA FRAME PC → Sensor

Byte0 Header	Byte1 Header	Byte2 Header	Byte3 Header	Byte4 Header	Byte5 Header	Byte6 Header	Byte7 Header
0x55	<order>	<ARG> (lo byte)	<ARG> (hi byte)	<LEN> (lo byte)	<LEN> (hi byte)	CRC8 (Data)	CRC8 (Header)
85 (dec)	7	0	0	0	0	170	82
ARG=0				LEN=0			

DATA FRAME Sensor → PC

ARG determines the serial number of the sensor

Byte0 Header	Byte1 Header	Byte2 Header	Byte3 Header	Byte4 Header	Byte5 Header	Byte6 Header	Byte7 Header	Byte8 Data	Byte9 Data	Byte10 Data	Byte11 Data
0x55	<order>	<ARG> (lo byte)	<ARG> (hi byte)	<LEN> (lo byte)	<LEN> (hi byte)	CRC8 (Data)	CRC8 (Header)	ASCII	ASCII	ASCII	ASCII
85 (dec)	7	0	0	72	0	183	38	F	I	R	M
ARG=0				LEN=72							

Byte12 Data	Byte13 Data	Byte14 Data	Byte15 Data	Byte16 Data	Byte17 Data	Byte18 Data	Byte19 Data	Byte20 Data	Byte21 Data	Byte22 Data	Byte23 Data
ASCII	ASCII	ASCII	ASCII	ASCII	ASCII	ASCII	ASCII	ASCII	ASCII	ASCII	ASCII
W	A	R	E		S	T	R	I	N	G	

Byte24 Data	Byte25 Data	Byte26 Data	Byte27 Data	Byte28 Data	Byte29 Data	Byte30 Data	Byte31 Data	Byte32 Data	Byte33 Data	Byte34 Data	Byte35 Data
ASCII	ASCII	ASCII	ASCII	ASCII	ASCII	ASCII	ASCII	ASCII	ASCII	ASCII	ASCII
											R

Byte36 Data	Byte37 Data	Byte38 Data	Byte39 Data	Byte40 Data	Byte41 Data	Byte42 Data	Byte43 Data	Byte44 Data	Byte45 Data	Byte46 Data	Byte47 Data
ASCII	ASCII	ASCII	ASCII	ASCII	ASCII	ASCII	ASCII	ASCII	ASCII	ASCII	ASCII
T	:	K	W	x	x	/	x	x			

Byte48 Data	Byte49 Data	Byte50 Data	Byte51 Data	Byte52 Data	Byte53 Data	Byte54 Data	Byte55 Data	Byte56 Data	Byte57 Data	Byte58 Data	Byte59 Data
ASCII	ASCII	ASCII	ASCII	ASCII	ASCII	ASCII	ASCII	ASCII	ASCII	ASCII	ASCII

Byte60 Data	Byte61 Data	Byte62 Data	Byte63 Data	Byte64 Data	Byte65 Data	Byte66 Data	Byte67 Data	Byte68 Data	Byte69 Data	Byte70 Data	Byte71 Data
ASCII	ASCII	ASCII	ASCII	ASCII	ASCII	ASCII	ASCII	ASCII	ASCII	ASCII	ASCII

Byte72 Data	Byte73 Data	Byte74 Data	Byte75 Data	Byte76 Data	Byte77 Data	Byte78 Data	Byte79 Data	Byte80 Data	Byte81 Data
ASCII	ASCII	ASCII	ASCII	ASCII	ASCII	ASCII	ASCII	ASCII	ASCII

Example order=8: Read data values from sensor.

DATA FRAME PC → Sensor

Byte0 Header	Byte1 Header	Byte2 Header	Byte3 Header	Byte4 Header	Byte5 Header	Byte6 Header	Byte7 Header
0x55	<order>	<ARG> (lo byte)	<ARG> (hi byte)	<LEN> (lo byte)	<LEN> (hi byte)	CRC8 (Data)	CRC8 (Header)
85 (dec)	8	0	0	0	0	170	118
ARG=0				LEN=0			

DATA FRAME Sensor → PC

8 Header Bytes

7 **DATA VALUE** type long

9 **DATA VALUE** type word

Example order=30: Start and Stop triggered sending of data frames

Start triggered sending of data frames
 DATA FRAME PC → Sensor

Byte0 Header	Byte1 Header	Byte2 Header	Byte3 Header	Byte4 Header	Byte5 Header	Byte6 Header	Byte7 Header
0x55	<order>	<ARG> (lo byte)	<ARG> (hi byte)	<LEN> (lo byte)	<LEN> (hi byte)	CRC8 (Data)	CRC8 (Header)
85 (dec)	30	1	0	0	0	170	82
ARG=1			LEN=0				

DATA FRAME Sensor → PC

Byte0 Header	Byte1 Header	Byte2 Header	Byte3 Header	Byte4 Header	Byte5 Header	Byte6 Header	Byte7 Header
0x55	<order>	<ARG> (lo byte)	<ARG> (hi byte)	<LEN> (lo byte)	<LEN> (hi byte)	CRC8 (Data)	CRC8 (Header)
85 (dec)	30	1	0	0	0	170	82
ARG=1			LEN=0				

Stop triggered sending of data frames
 DATA FRAME PC → Sensor

Byte0 Header	Byte1 Header	Byte2 Header	Byte3 Header	Byte4 Header	Byte5 Header	Byte6 Header	Byte7 Header
0x55	<order>	<ARG> (lo byte)	<ARG> (hi byte)	<LEN> (lo byte)	<LEN> (hi byte)	CRC8 (Data)	CRC8 (Header)
85 (dec)	30	0	0	0	0	170	159
ARG=0			LEN=0				

DATA FRAME Sensor → PC

Byte0 Header	Byte1 Header	Byte2 Header	Byte3 Header	Byte4 Header	Byte5 Header	Byte6 Header	Byte7 Header
0x55	<order>	<ARG> (lo byte)	<ARG> (hi byte)	<LEN> (lo byte)	<LEN> (hi byte)	CRC8 (Data)	CRC8 (Header)
85 (dec)	30	0	0	0	0	170	159
ARG=0			LEN=0				

Example order=105: Get cycle time from sensor

DATA FRAME PC → Sensor

Byte0 Header	Byte1 Header	Byte2 Header	Byte3 Header	Byte4 Header	Byte5 Header	Byte6 Header	Byte7 Header
0x55	<order>	<ARG> (lo byte)	<ARG> (hi byte)	<LEN> (lo byte)	<LEN> (hi byte)	CRC8 (Data)	CRC8 (Header)
85 (dec)	105	0	0	0	0	170	130
ARG=0			LEN=0				

DATA FRAME Sensor → PC

Byte0 Header	Byte1 Header	Byte2 Header	Byte3 Header	Byte4 Header	Byte5 Header	Byte6 Header	Byte7 Header	Byte8 Data	Byte9 Data	Byte10 Data	Byte11 Data
0x55	<order>	<ARG> (lo byte)	<ARG> (hi byte)	<LEN> (lo byte)	<LEN> (hi byte)	CRC8 (Data)	CRC8 (Header)	lo word lo byte	lo word hi byte	hi word lo byte	hi word hi byte
85 (dec)	105	0	0	8	0	206	163	40	28	2	0
ARG=0			LEN=8		CYCLE COUNT = 138280						

Byte12 Data	Byte13 Data	Byte14 Data	Byte15 Data
lo word lo byte	lo word hi byte	hi word lo byte	hi word hi byte
144	1	0	0
COUNTER TIME = 400			

Cycle Time [Hz] = CYCLE COUNT / (COUNTER TIME * 0,01)

Cycle Time [ms] = (COUNTER TIME * 0,01) / CYCLE COUNT

Example order=190: Write new baud rate to the sensor.

DATA FRAME PC → Sensor

Byte0 Header	Byte1 Header	Byte2 Header	Byte3 Header	Byte4 Header	Byte5 Header	Byte6 Header	Byte7 Header	
0x55	<order>	<ARG> (lo byte)	<ARG> (hi byte)	<LEN> (lo byte)	<LEN> (hi byte)	CRC8 (Data)	CRC8 (Header)	
85 (dec)	190	1	0	0	0	170	14	
ARG=1			LEN=0					

New baud rate is determined by argument.

- ARG=0: baud rate = 9600
- ARG=1: baud rate = 19200
- ARG=2: baud rate = 38400
- ARG=3: baud rate = 57600
- ARG=4: baud rate = 115200
- ARG=5: baud rate = 230400
- ARG=6: baud rate = 460800

DATA FRAME Sensor → PC

Byte0 Header	Byte1 Header	Byte2 Header	Byte3 Header	Byte4 Header	Byte5 Header	Byte6 Header	Byte7 Header	
0x55	<order>	<ARG> (lo byte)	<ARG> (hi byte)	<LEN> (lo byte)	<LEN> (hi byte)	CRC8 (Data)	CRC8 (Header)	
85 (dec)	190	0	0	0	0	170	195	
ARG=0			LEN=0					